

CUKUROVA®
polistren dekor



MUTLULUĞUNUZUN
KAPLADIĞI
HER YERDE

Biz Varız...

“

Çukurova Polistren Dekor, yapı sektörüne özel olarak geliştirdiği yenilikçi çözümlerle dış cephe ve iç cephe dekorasyonunda estetiği, dayanıklılığı ve fonksiyonelliği bir araya getirir. EPS ürün grubu başta olmak üzere hazır kartonpiyer, tavan kaplama, denizlik, fuga, lamba göbeği, motif, sütun, giriş ve şömine gibi çok çeşitli ürünlerle her ölçekteki projeye estetik değer katar. Aynı zamanda mantolama sistemleri ve izolasyon çözümleriyle yapılar için enerji verimliliğini destekleyen güçlü bir altyapı sunar.

Kaliteli üretim anlayışını modern teknolojiyle birleştiren firmamız, Adana'daki entegre tesislerinde yüksek üretim kapasitesi ile faaliyet göstermektedir. Sadece ürün değil, çözüm üreten bir marka olma vizyonuyla, mimarların, müteahhitlerin ve nihai kullanıcıların beklentilerini karşılayan esnek ve sürdürülebilir çözümler geliştiriyoruz.

İhracat ağıımızı Orta Doğu, Afrika ve Asya başta olmak üzere pek çok ülkeye genişleterek Türk yapı sektörünün uluslararası alanda temsilciliğini başarıyla üstleniyoruz.

Her bir üretim sürecinde kalite standartlarını titizlikle uygulayan firmamız; **ISO 9001, ISO 14001 ve ISO 45001 belgeleri ile sertifikalandırılmıştır**. Bu belgeler, ürünlerimizin yalnızca görsel değil, teknik olarak da uluslararası kalite beklentilerini karşıladığını belgelemektedir.

Çukurova Polistren Dekor olarak, güvenilirliği, sürdürülebilirliği ve yüksek müşteri memnuniyetini temel alan yönetim anlayışımızla; sektöre değer katmaya, markamızı daha ileriye taşımaya ve müşterilerimizin her projesinde güvenilir bir çözüm ortağı olmaya devam ediyoruz.

”

“

Misyonumuz

Yapı sektörüne estetik, kaliteli ve sürdürülebilir çözümler sunarak; yaşam alanlarını daha güvenli, daha fonksiyonel ve daha değerli hale getirmek. Müşterilerimize her zaman yenilikçi, uzun ömürlü ve ekonomik ürünler sunmayı, hizmette güven ve kaliteden ödün vermeden faaliyet göstermeyi görev biliyoruz.

”

“

Vizyonumuz

Polistren dekorasyon ve izolasyon sistemlerinde ulusal ve uluslararası ölçekte öncü bir marka olmak. Tasarım, üretim ve hizmette mükemmelliği yakalayarak; yapı sektörünün ihtiyaçlarını geleceğe taşıyan, yeniliği benimseyen, çevreye ve insana duyarlı bir firma olmak.

”

GÜVEN

Müşterilerimiz, iş ortaklarımız ve çalışanlarımızla karşılıklı güvene dayalı ilişkiler kurarız.

KALİTE

Her ürünümüzde ve hizmetimizde yüksek kalite standardını korur, sürekli iyileştirmeyi hedefleriz.

SÜRDÜRÜLEBİLİRLİK

Çevre dostu üretim ve uzun ömürlü çözümlerle sürdürülebilir bir gelecek inşa ederiz.

YENİLİKÇİ

Teknolojiyi yakından takip eder, sektöre öncülük edecek yenilikleri geliştiririz.

EKİP RUHU

Birlikte üretmenin ve başarmanın gücüne inanır, ekip çalışmasını teşvik ederiz.

MÜŞTERİ ODAKLILIK

İhtiyaçları doğru analiz eder, her projeye özel çözümler sunarız.

Üretim Gücümüz

Çukurova Polistren Dekor, Adana'da yer alan yüksek kapasiteli üretim tesisinde faaliyet göstermektedir. Son teknoloji makine parkurumuz ve alanında uzman kadromuz ile; EPS blok kesim, CNC desen işleme, özel kalıp üretimi ve paketleme dahil olmak üzere tüm süreçler kendi bünyemizde gerçekleştirilmektedir.

Modern üretim tesislerimiz sayesinde: Yüksek adetli seri üretim kapasitesi Müşteriye özel esnek üretim çözümleri Hızlı termin süreleri Kalite kontrolü %100 iç süreçlerde sağlanır.

Yurt içi ve yurt dışı pazarlara güvenle sunduğumuz ürünlerimiz, TSE ve CE belgeleri ile belgelenmiş kalite anlayışımızın bir göstergesidir. Üretimdeki gücümüz, projelerinizde fark yaratma iddiamızın temelini oluşturur.

İÇ CEPHE ÜRÜNLER

Interior Product

cukurova[®]
polistren dekor

06 KARTONPİYER

11 PERDELİK

12 ÇITA

13 IŞIK BANDI

16 IŞIKLI ASMA TAVAN

18 TV ÜNİTELERİ

19 ŞÖMİNE

20 İÇ CEPHE MOTİF

30 EPS KARTONPİYER

32 ÇITA KÖŞESİ VE DESENLİ ÇITA

33 LAMBA GÖBEĞİ

35 TAVAN KAPLAMA

DIŞ CEPHE ÜRÜNLER

Exterior Product

38 SÖVE

45 TAÇ

48 TAÇ DEKOR

50 DENİZLİK

53 KAT SİLMESİ

60 HARPUŞTA

60 YUVARLAK PENCERE

60 BALUSTRAT

60 ÇITA

64 LEDLİ ÜRÜNLER

67 KÖŞE ELEMANLARI

69 ENJ. KÖŞE ELEMANLARI

70 BORU KAPLAMA

71 SÜTUN & KAİDE

77 PAYANDA

79 KİLİT TAŞI

80 ROZET

81 MOTİF

84 FUGA

88 ENJ. FUGA

89 TUĞLA FUGA

90 ÖRNLK. PENCERE MODEL

91 YARDIMCI ÜRÜNLER

92 YALITIM MALZEMELERİ

93 MANTOLAMA

İÇ CEPHE ÜRÜNLER

Interior Product

المنتج الداخلة



Yüksek dansite
EPS ve XPS ürünlerin
şekillendirilmesiyle elde edilir.

All the products are obtained
with high density EPS and XPS.

كل المنتجات تصنع من مادة البوليسترين هي ذو كثافة عالية

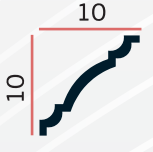
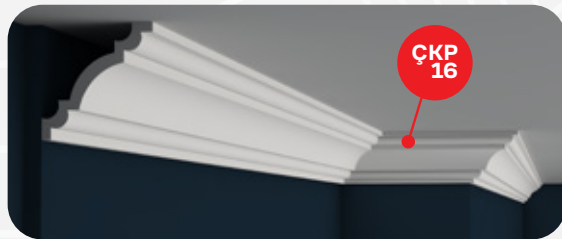
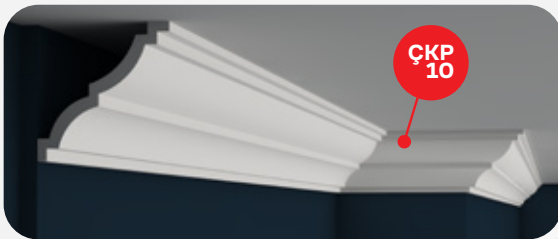
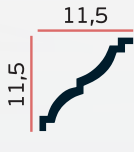
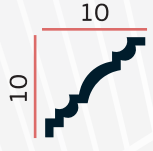
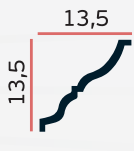
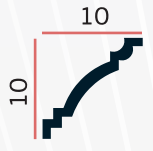
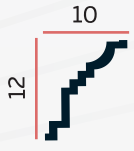
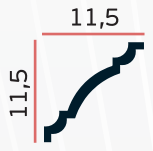
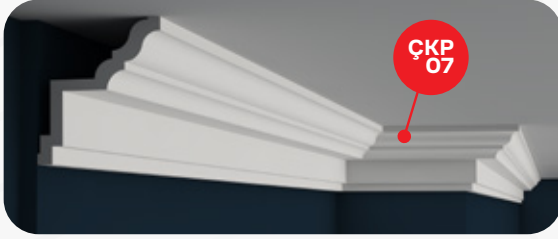
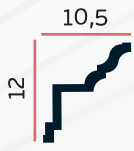
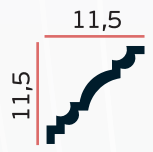
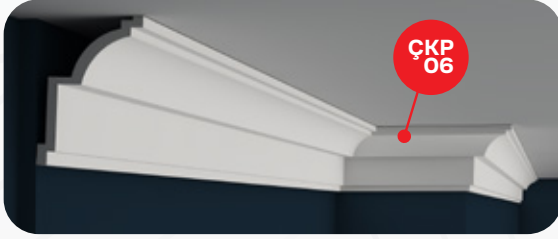
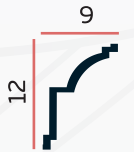
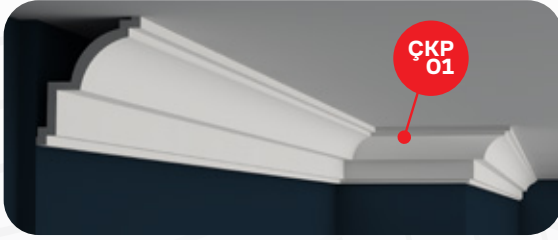
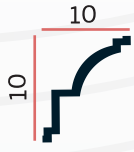

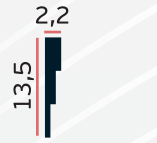
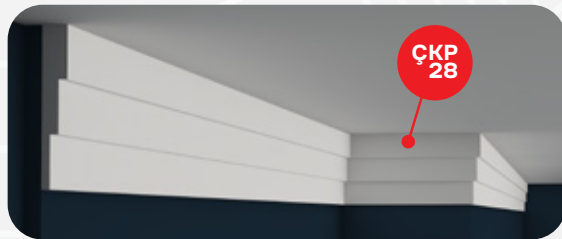
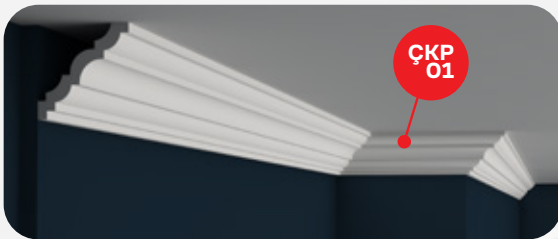
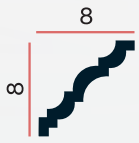
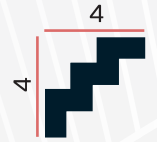
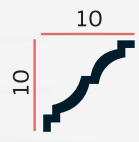
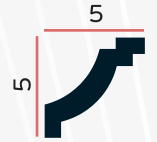
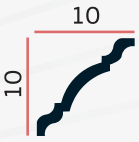
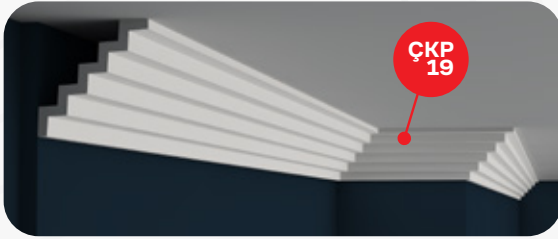
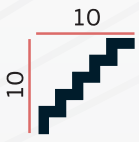
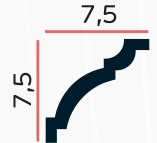
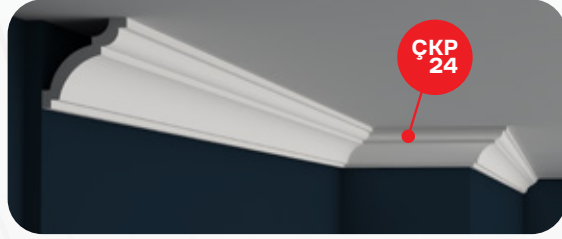
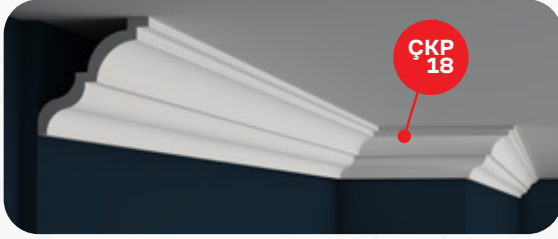
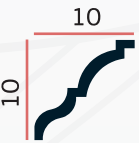
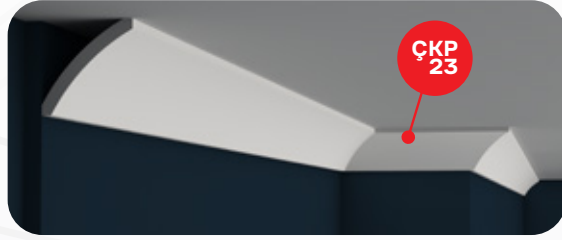
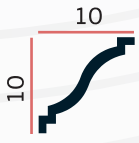

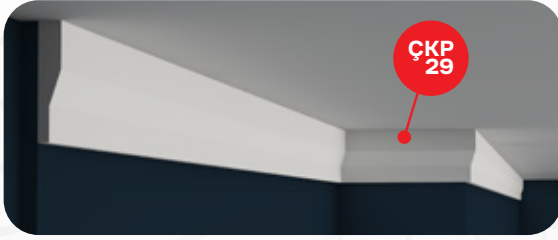
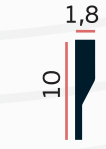

ÇKP
29

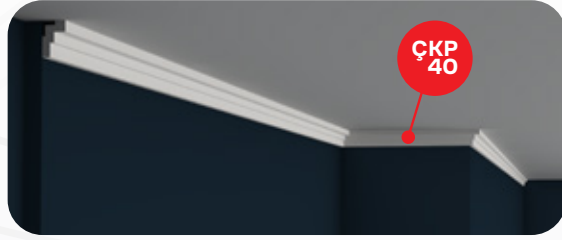

ÇKP
40

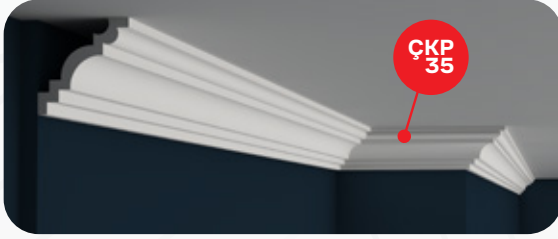
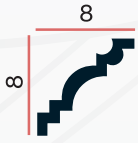
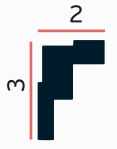

ÇKP
35

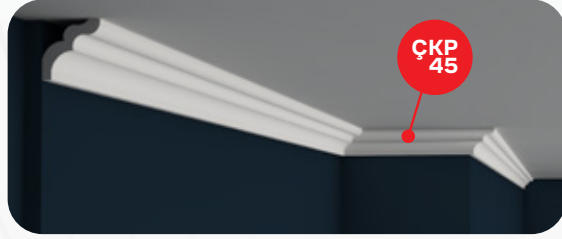

ÇKP
45

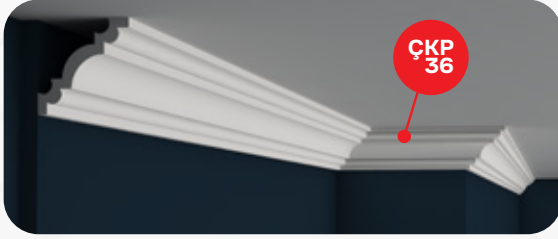
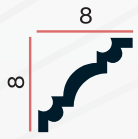
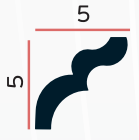

ÇKP
36

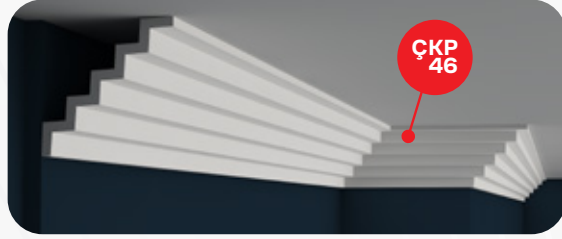

ÇKP
46

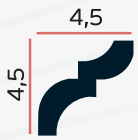
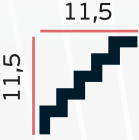

ÇKP
37



ÇKP
47

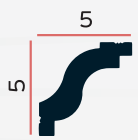

ÇKP
38



ÇKP
48

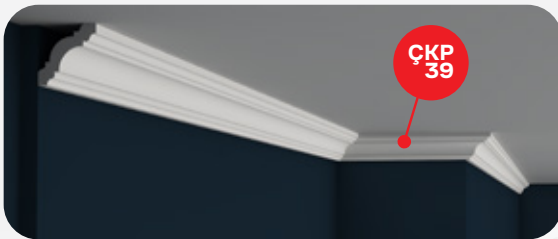
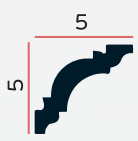
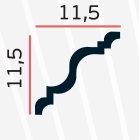

ÇKP
39

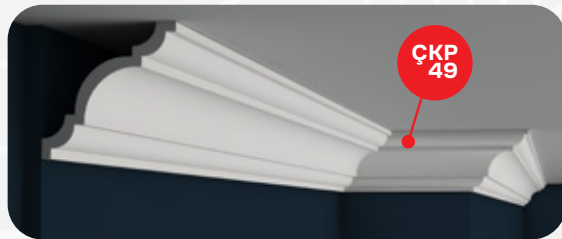

ÇKP
49

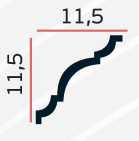

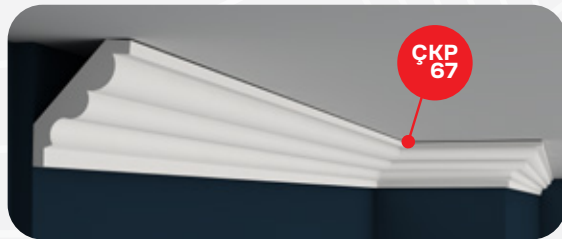
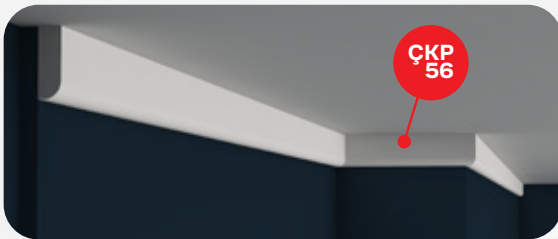
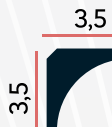
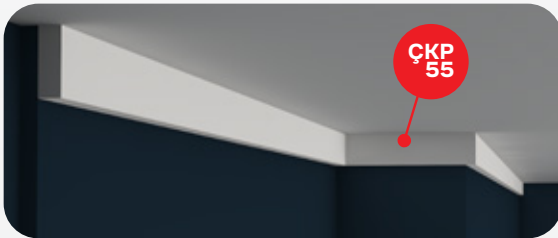
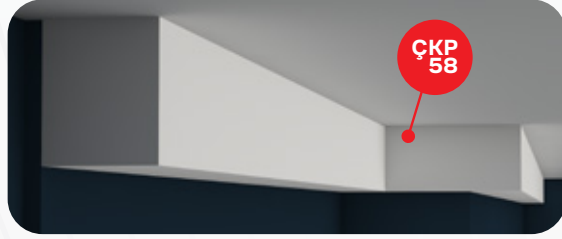
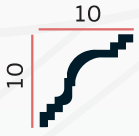
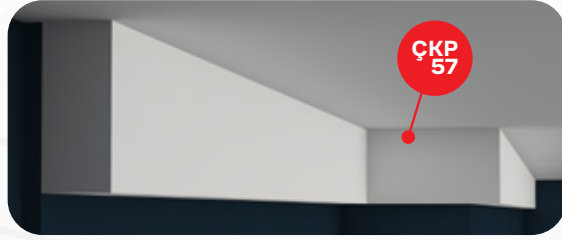
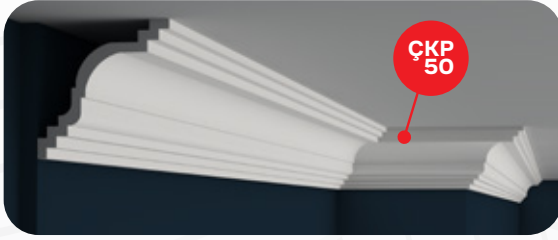
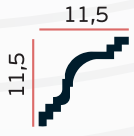

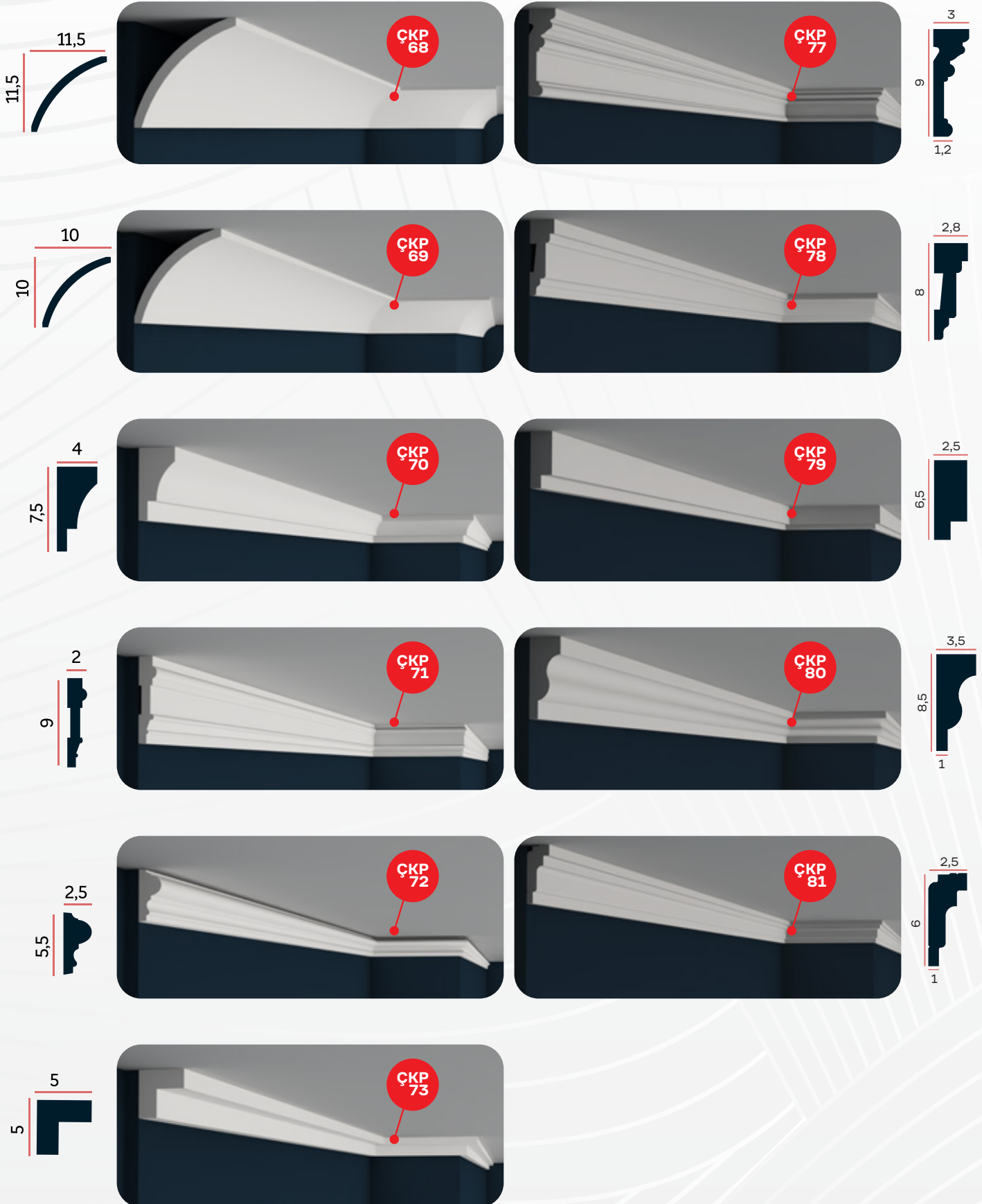

KARTONPİYER

Papier Mache
بنل فلين داخلي

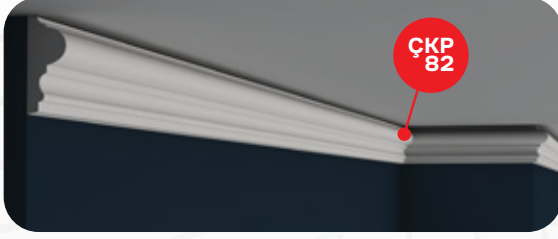

ÇKP
82



ÇKP
87

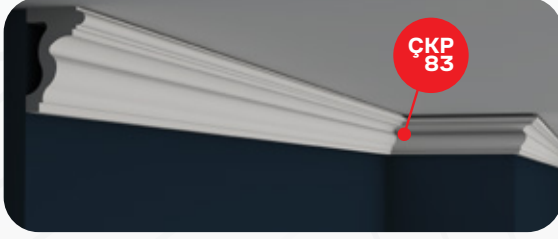
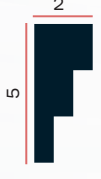

ÇKP
83



ÇKP
88

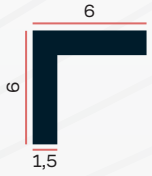
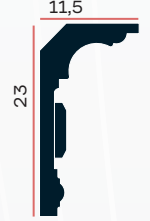

ÇKP
84



ÇKP
85

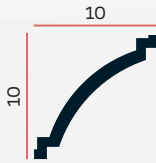

ÇKP
86



EN KALİTELİ
YAPIŞTIRICILAR
CUKUROVA®
polistren dekor
AİLESİNDE

PERDELİK

Interior Lath
الركيزة

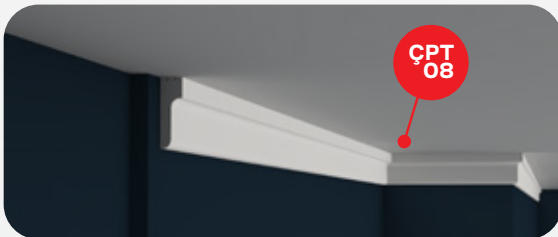

ÇPT
08



ÇPT
10



ÇPT
12

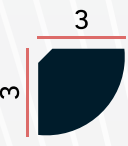
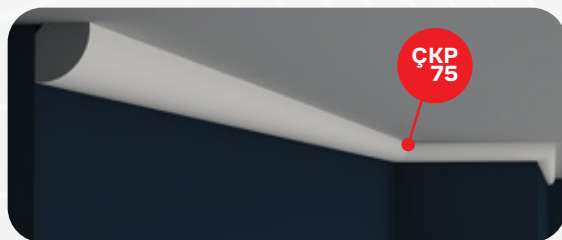
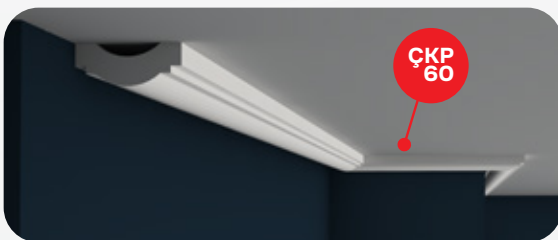
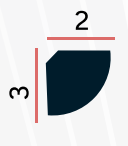
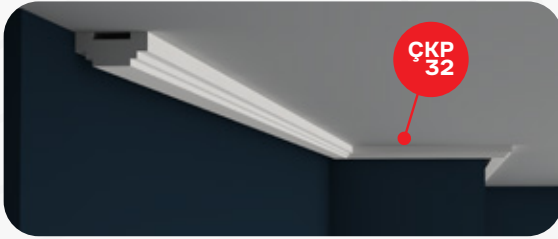
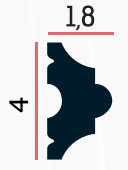
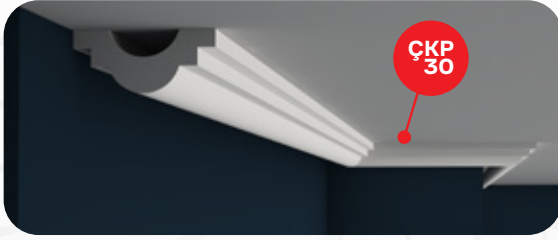

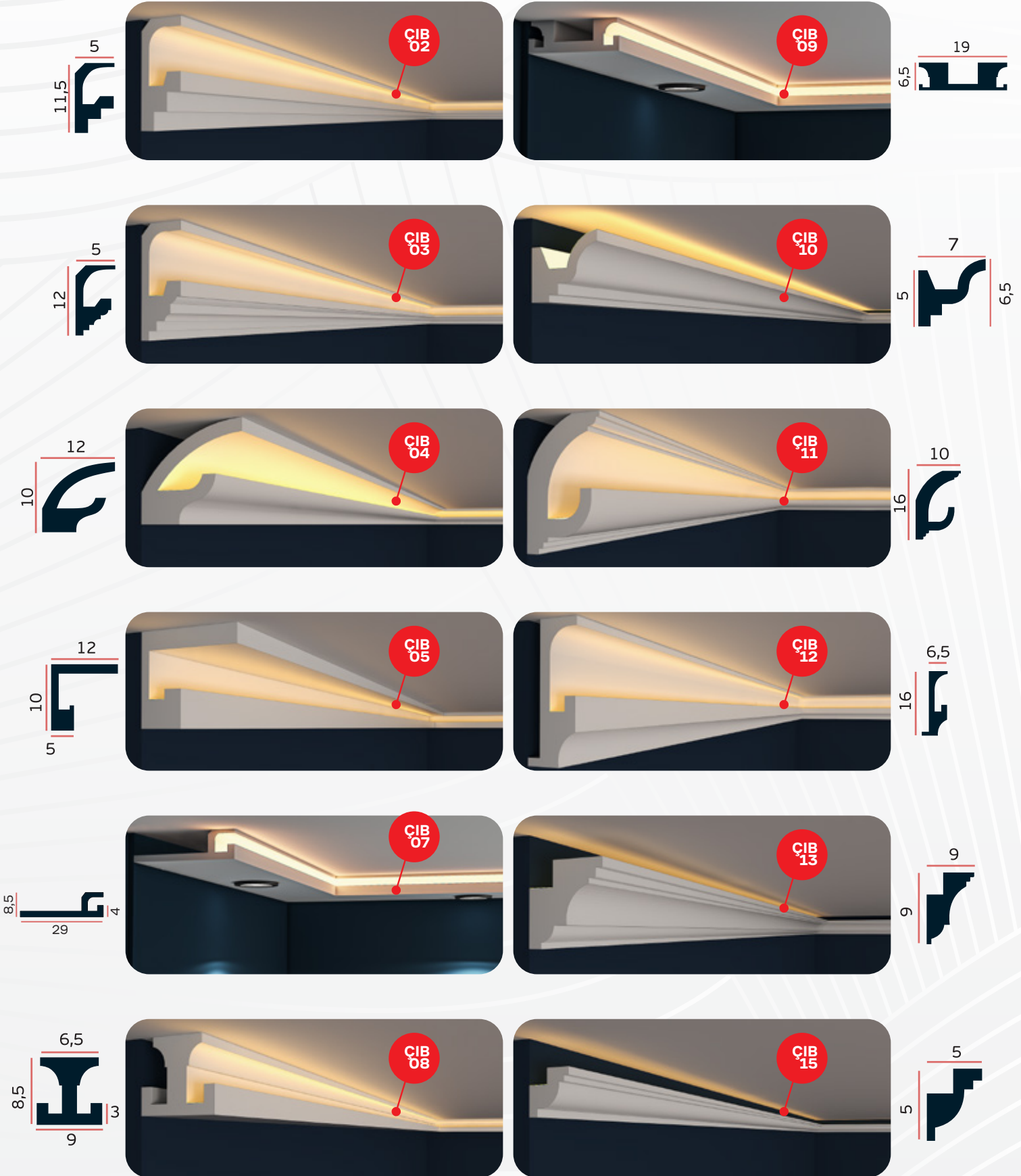

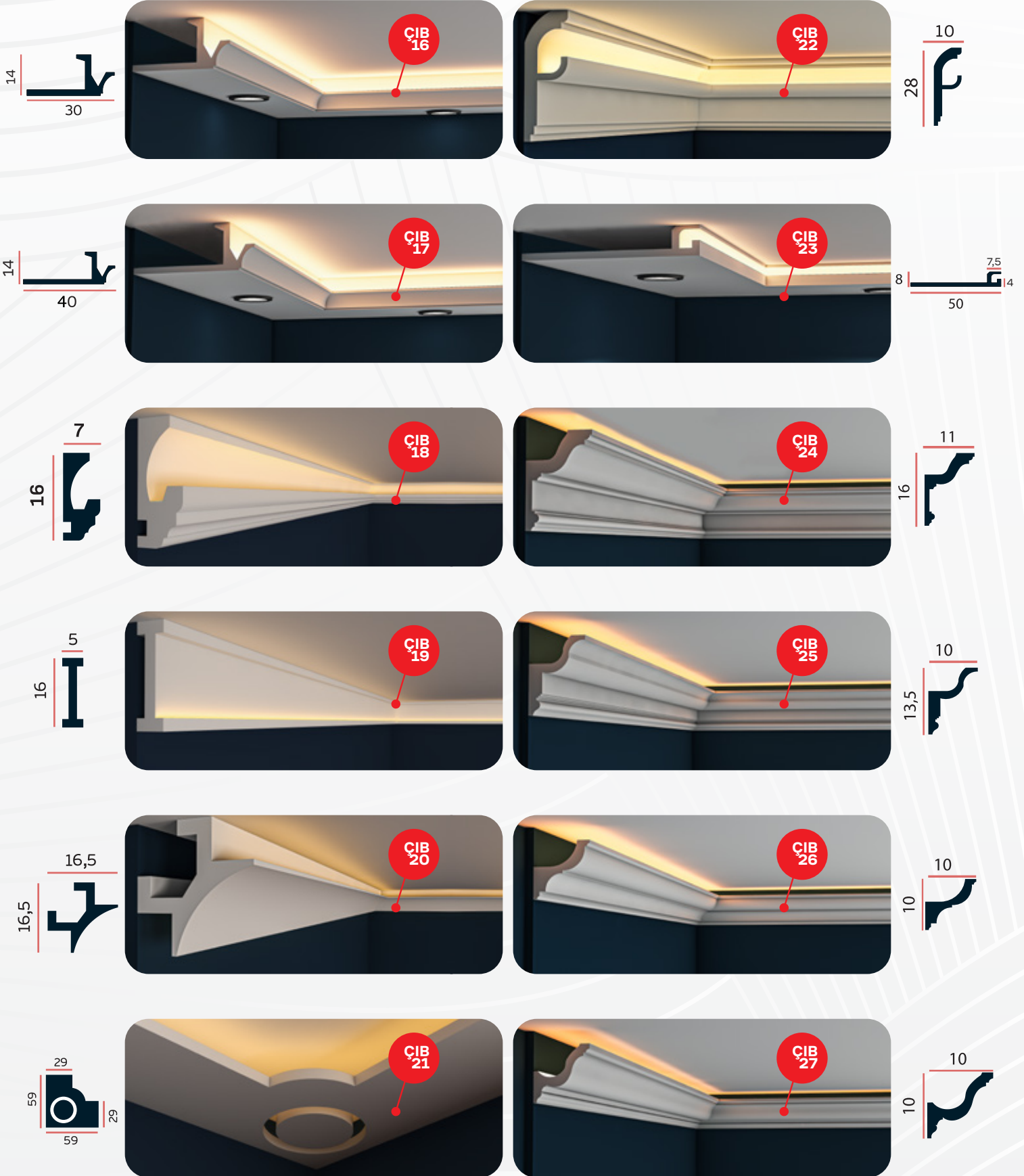



CIB
28



CIB
32

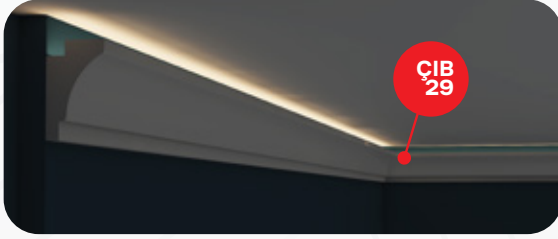
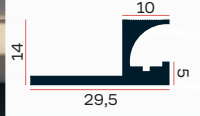

CIB
29

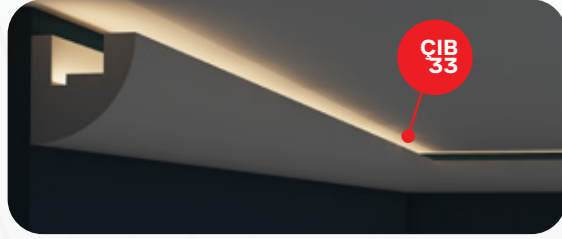

CIB
33

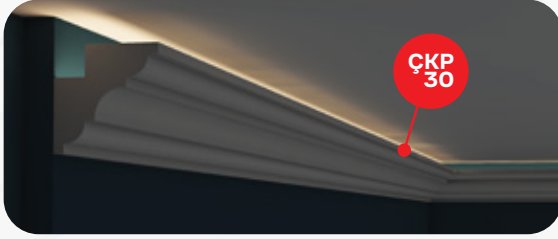
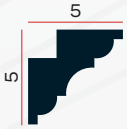
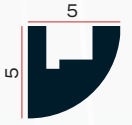

ÇKP
30

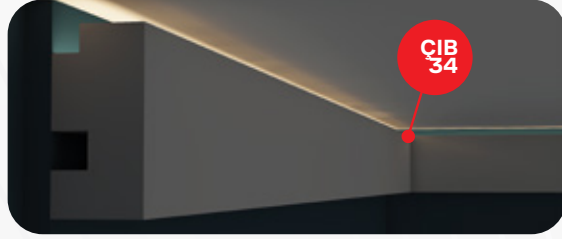

CIB
34

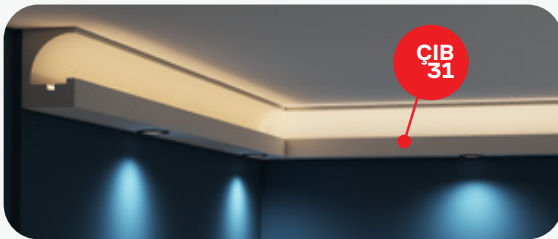
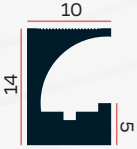

CIB
31



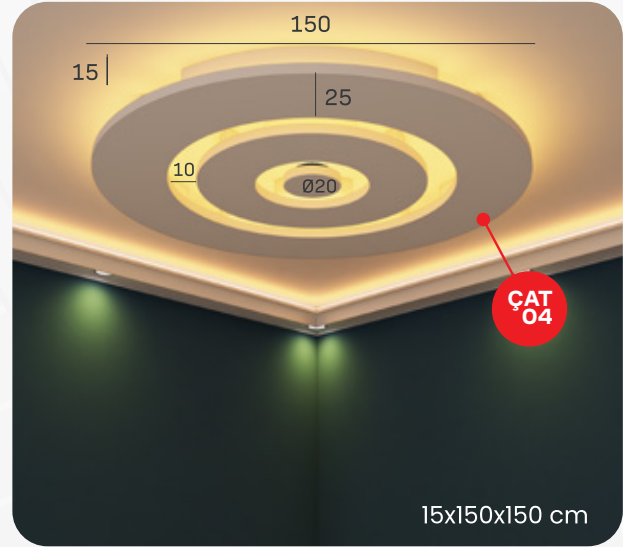
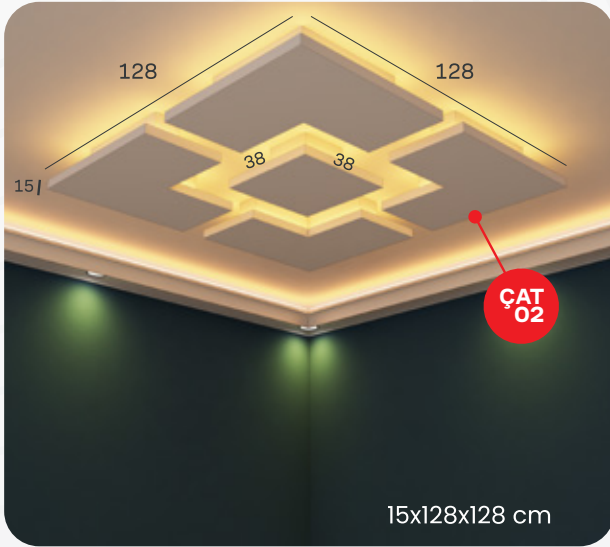
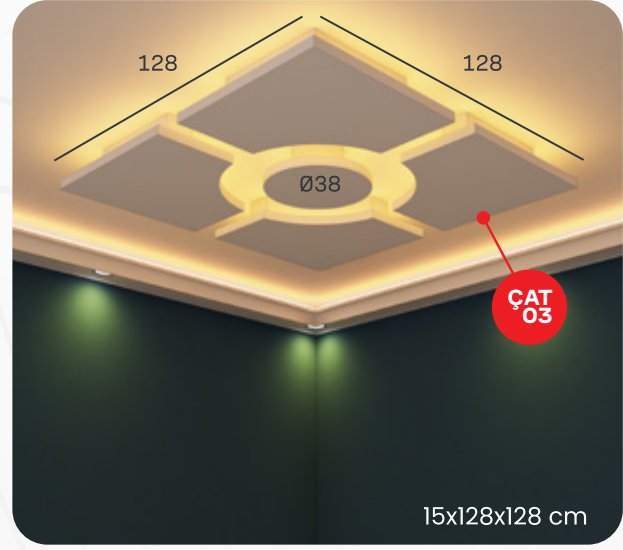
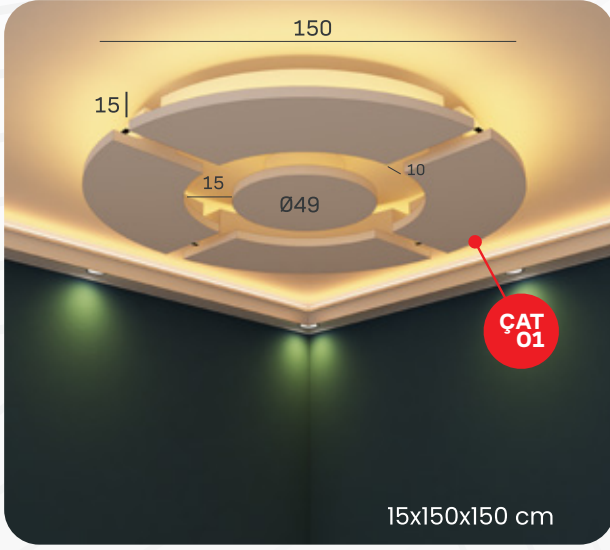

ÜRÜNLERİMİZ
YÜKSEK YOĞUNLUKTA
XPS
(EKSTRUDE POLİSTREN)
HAMMADDEDEN
ÜRETİLMEKTEDİR!



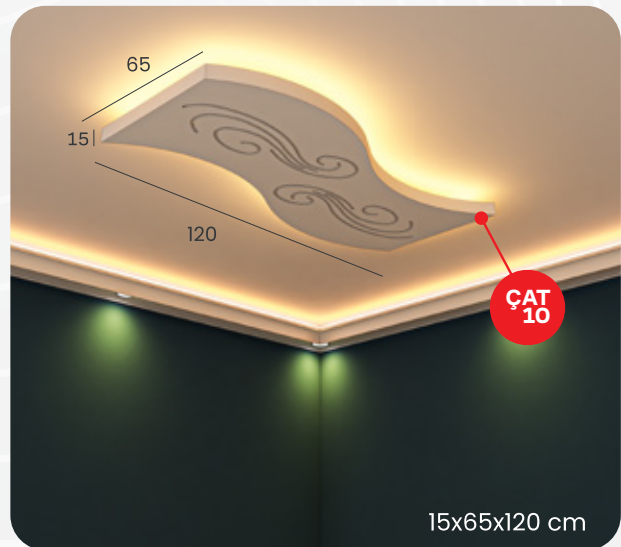
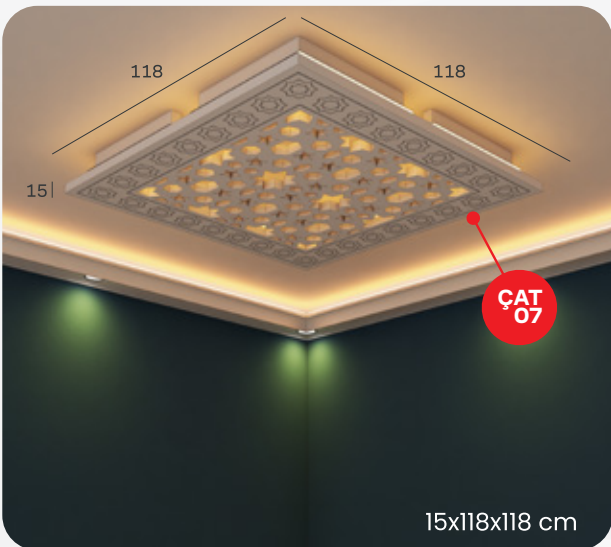
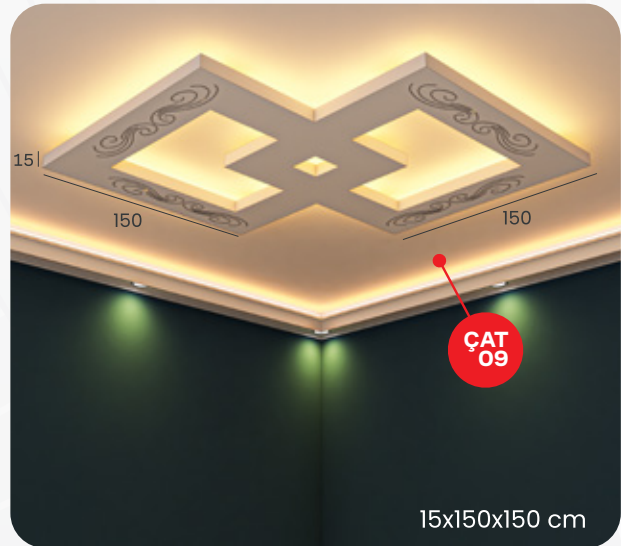
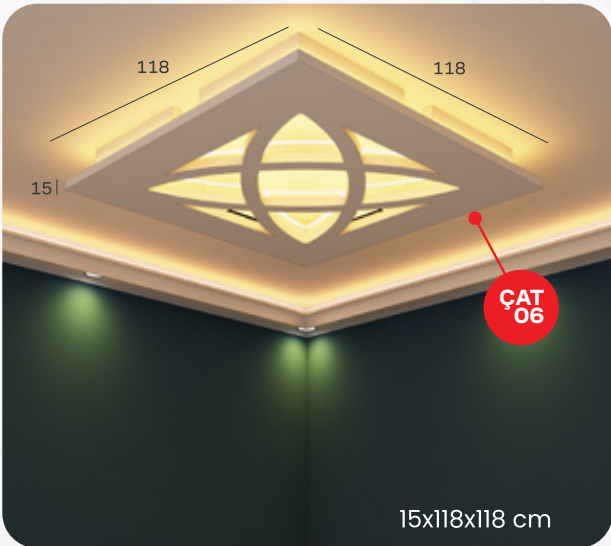
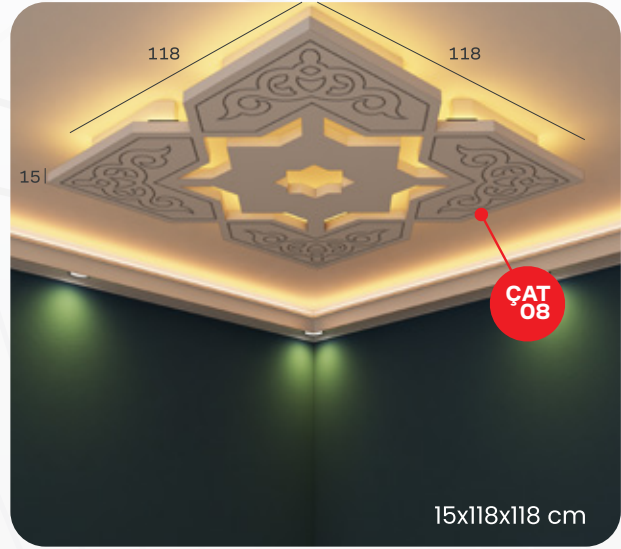
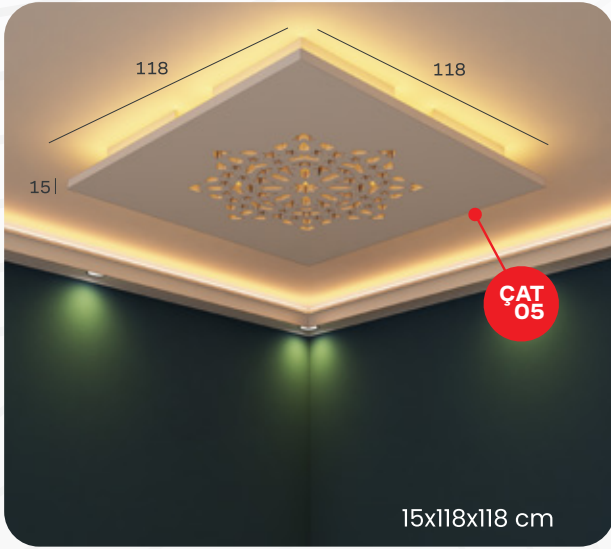

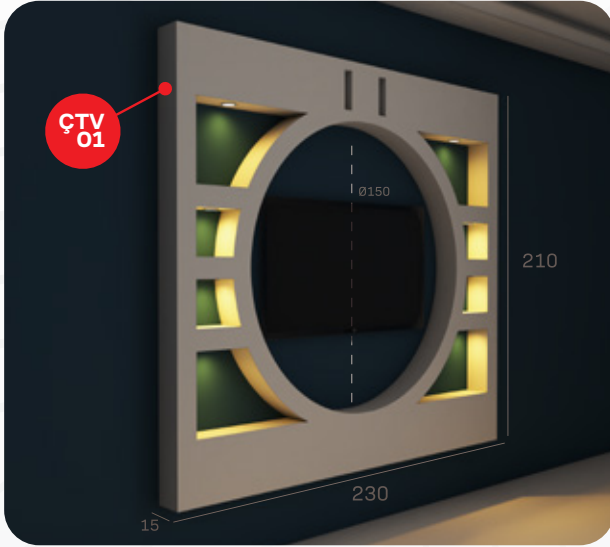

15x210x230 cm



15x200x250 cm

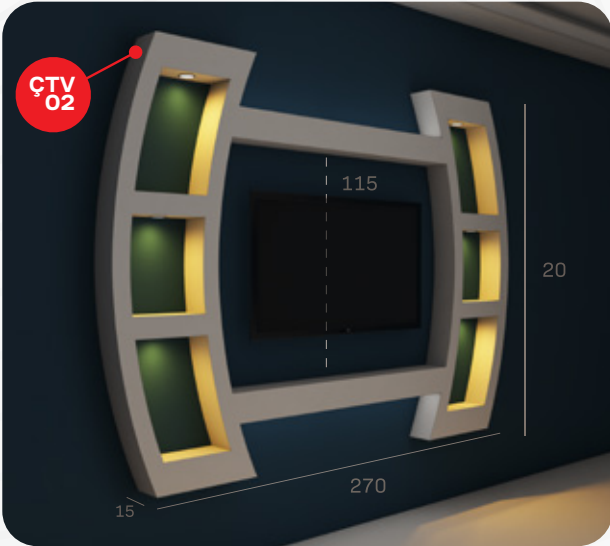

15x200x270 cm



15x200x250 cm



15x230x260 cm

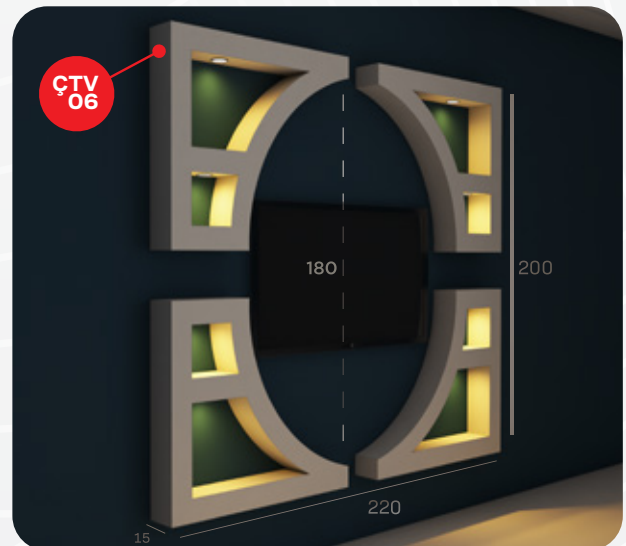

15x200x220 cm

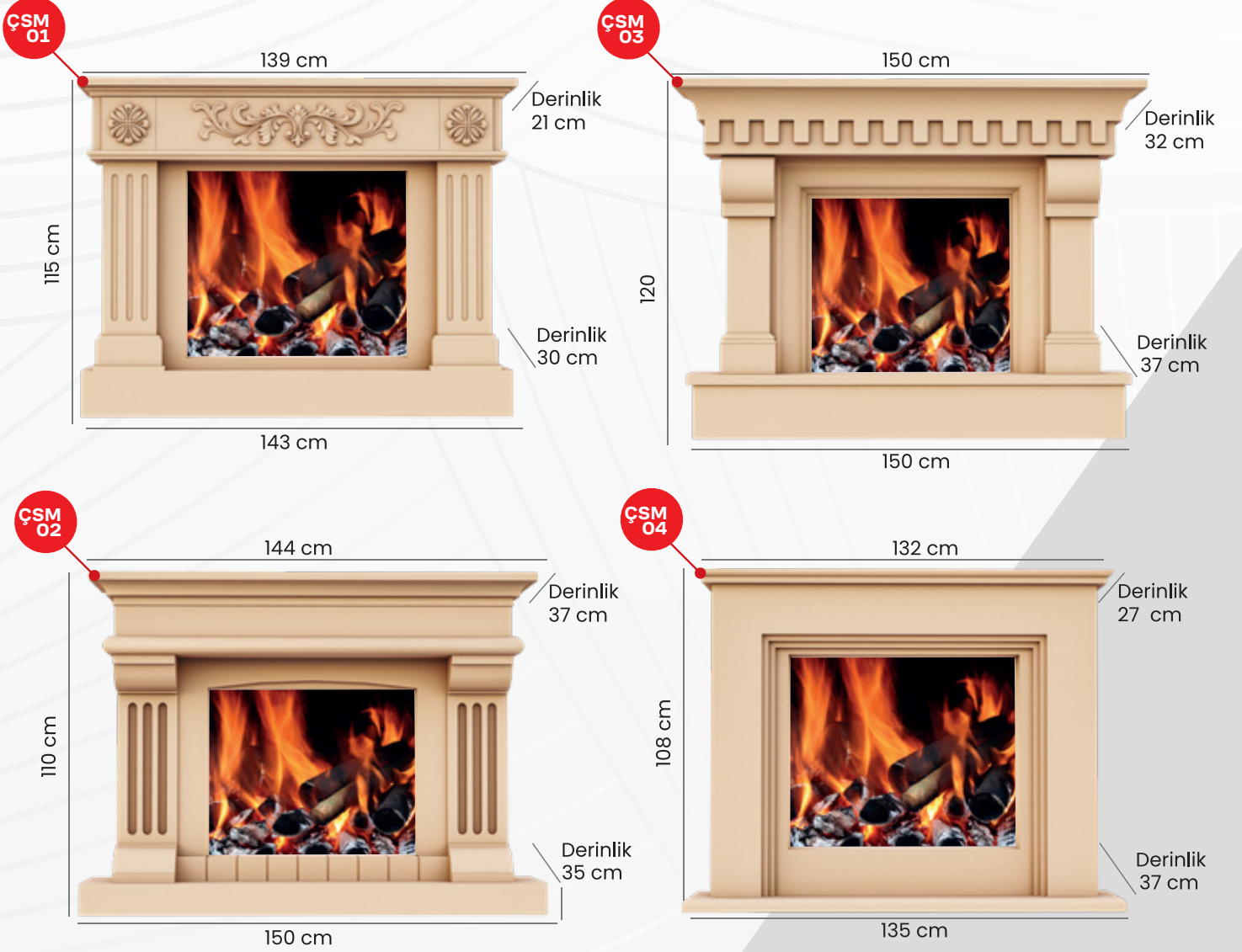



ÇİM
01

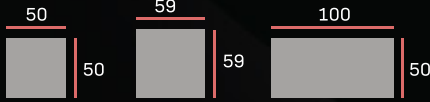

Ürünlerimizin kalınlığı 1,4 cm'dir



100 cm

50 cm



ÇİM
02

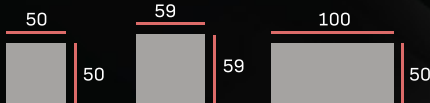

Ürünlerimizin kalınlığı 1,4 cm'dir



100 cm

50 cm



ÇİM
03

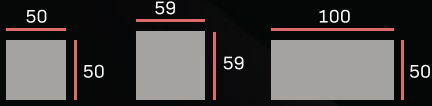

Ürünlerimizin kalınlığı 1,4 cm'dir



50 cm

100 cm



ÇİM
04

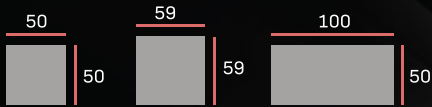

Ürünlerimizin kalınlığı 1,4 cm'dir



50 cm

100 cm



ÇİM 05

1,4x50x100 cm



ÇİM 06

1,4x50x100 cm



ÇİM 07

1,4x50x100 cm



ÇİM 08

1,4x50x100 cm



ÇİM 09

1,4x50x100 cm

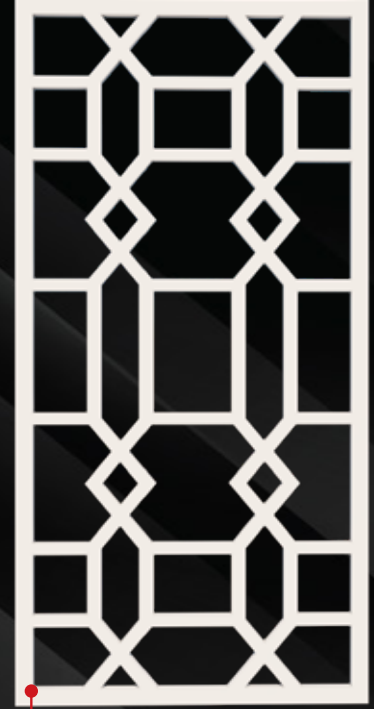

ÇİM 10

1,4x50x100 cm



1,4x105 cm



1,4x105 cm
1,4x160 cm



1,4x115 cm



1,4x110 cm



1,4x59x59 cm



1,4x59x65 cm

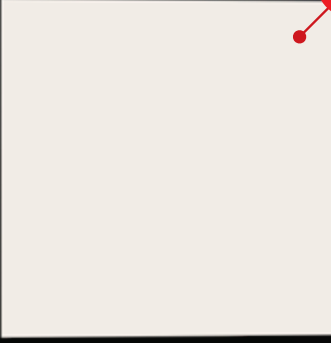

0,5x50x50 cm
0,5x59x59 cm
0,5x50x100 cm



1,4x59 cm



1,4x59x59 cm



1,4x59x59 cm

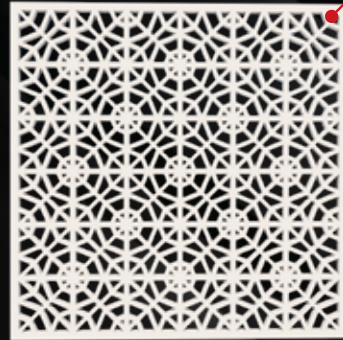

1,4x59x59 cm



1,4x59x59 cm

1,4x58x198 cm

ÇİM
19



198 cm

58 cm

2.185.315

ÇİM
20



2x150x390 cm

çim 22



çim 23



20 cm

1,4x20x198 cm



30 cm

1,4x30x198 cm



40 cm

1,4x40x198 cm

198 cm

çim 24



19,5 cm

1,4x19,5x198 cm

198 cm

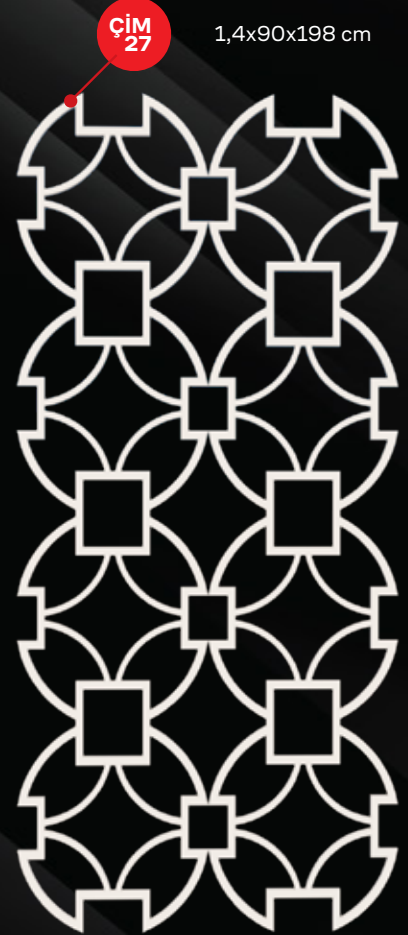

1,4x50x198 cm

ÇİM
33

1,4x180x273 cm



ÇİM
31

1,4x119x255 cm



ÇİM
34

1,4x80x150 cm





ÇİM
13

1,4x110 cm
1,4x150 cm
1,4x190 cm



ÇİM
14

1,4x150 cm
1,4x200 cm
1,4x300 cm



ÇİM
13

6,5x59 cm



ÇİM
14

4,5x150 cm

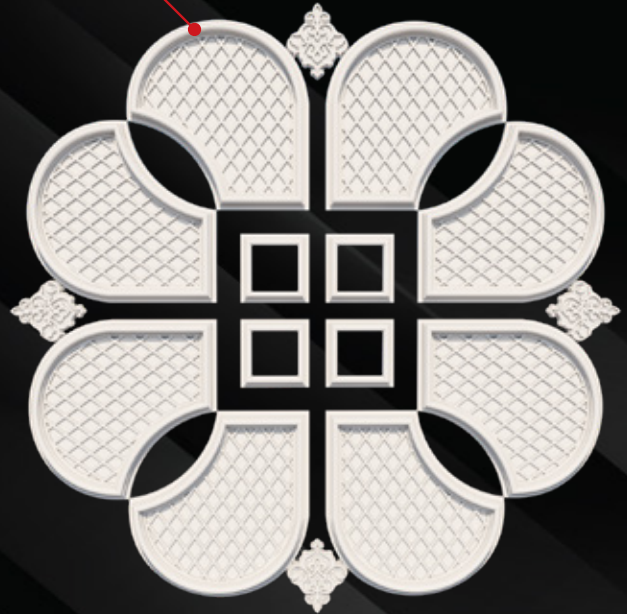

ÇEDK
02



ÇEDK
03



ÇEDK
06



ÇEDK
10



ÇEDK
11



ÇEDK
12



ÇEDK
13



ÇEDK
14

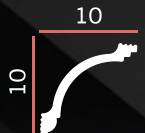

ÇEDK
17



ÇEDK
18



ÇEDK
19



ÇEDK
21



ÇEDK
22

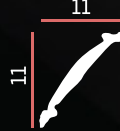

ÇEDK
23



ÇEDK
24



ÇEDK
25



ÇEDK
27



ÇEDK
28



ÇITA KÖŞESİ VE DESENLİ ÇITA

Interior Lath
الركيزة





ÇGB
01

Ø39
Ø47
Ø55



ÇGB
02

Ø47



ÇGB
03

Ø47



ÇGB
04

Ø47



ÇGB
05

Ø39
Ø47



ÇGB
07

Ø47
Ø55
Ø70



ÇGB
10

Ø55



ÇGB
08

Ø70



ÇGB
11

Ø55



ÇGB
09

Ø70



ÇGB
12

Ø70

ÇTK
02

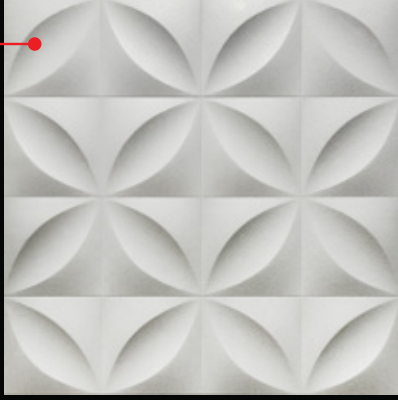

50x50 cm

ÇTK
08



50x50 cm

ÇTK
03

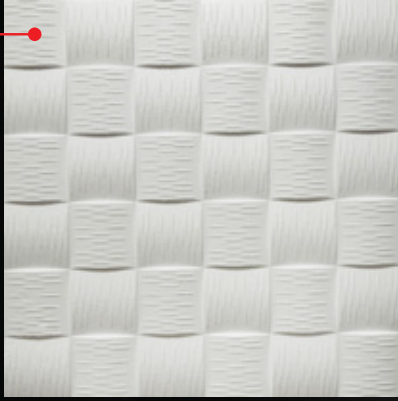

50x50 cm

ÇTK
09



50x50 cm

ÇTK
05



50x50 cm

ÇTK
10

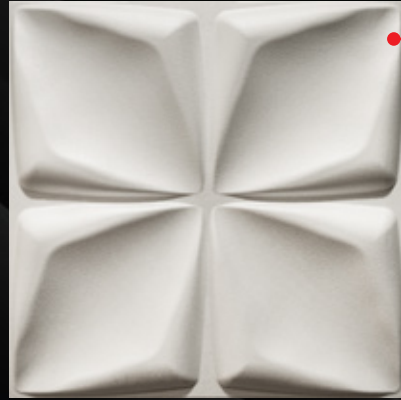

50x50 cm

ÇTK
07



50x50 cm

ÇTK
11

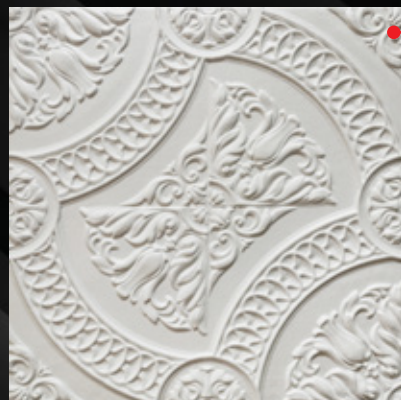

50x50 cm

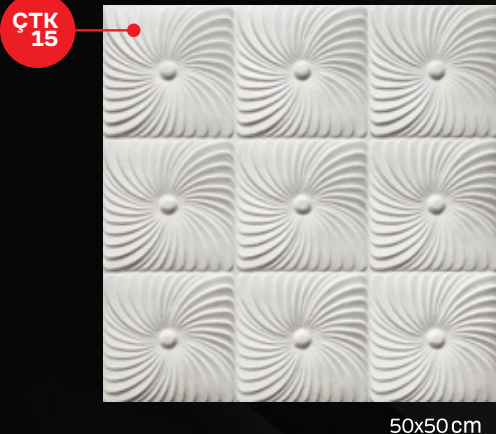
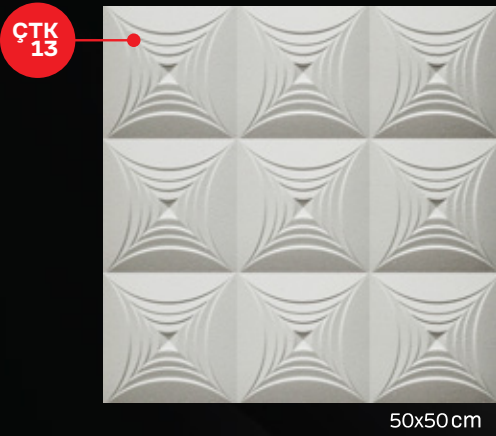
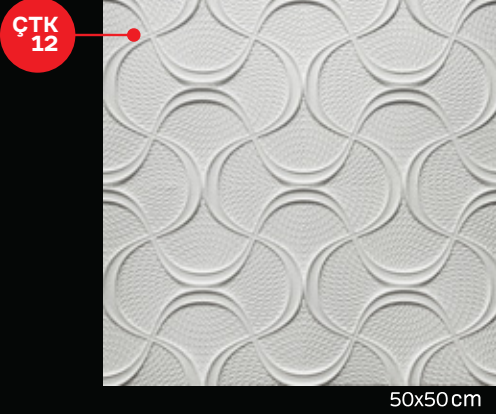

TAVAN KAPLAMA EN İYİ CYRD-10 İLE YAPIŞTIRILIR



DIŞ CEPHE ÜRÜNLER

Exterior Product

المنتجات الخارجية



Yüksek dansite EPS ürünlerin şekillendirilmesiyle elde edilen polistrene, birden çok kimyasal maddenin karıştırılmasıyla oluşan akrilik esaslı reçinenin kaplanmasıyla elde edilir.

All the products are obtained with shaping high density EPS with covering of acrylic compounds.

كل المنتجات مصنعة من البوليسترين هي ذو كثافة عالية مع خليط من مواد كيميائية متعددة كالأكرليك

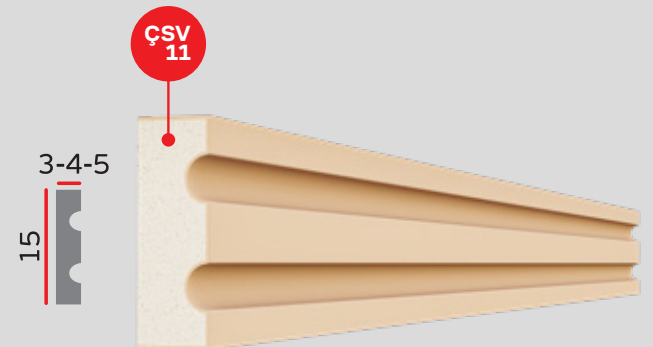
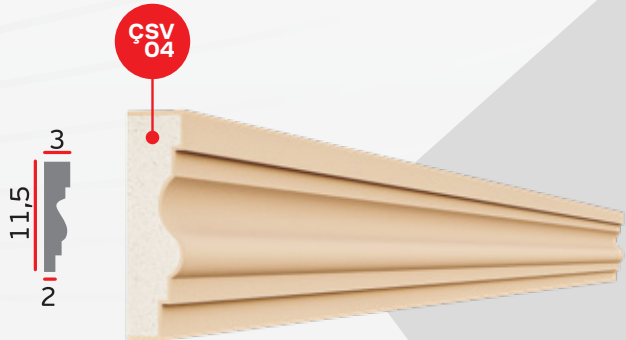
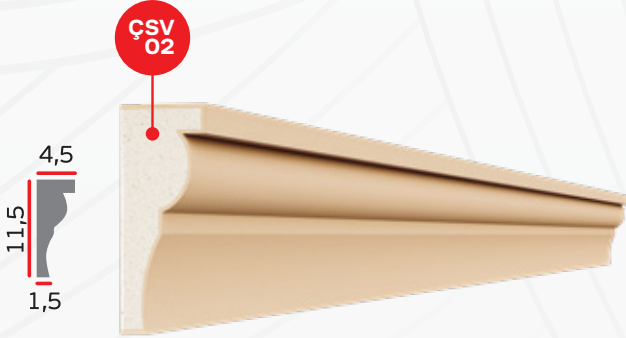

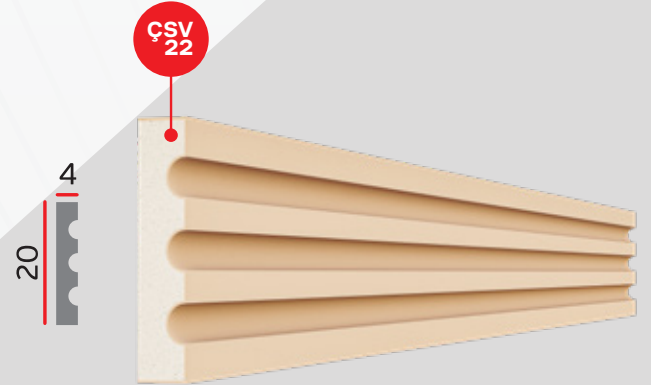
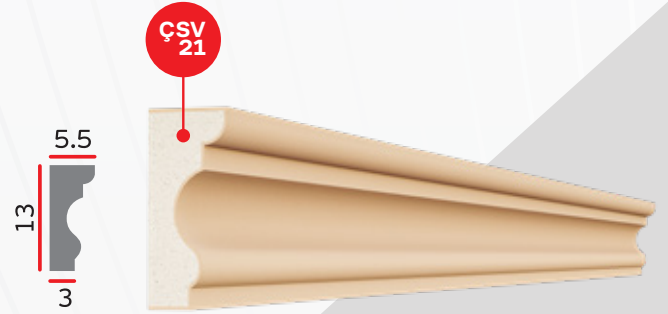
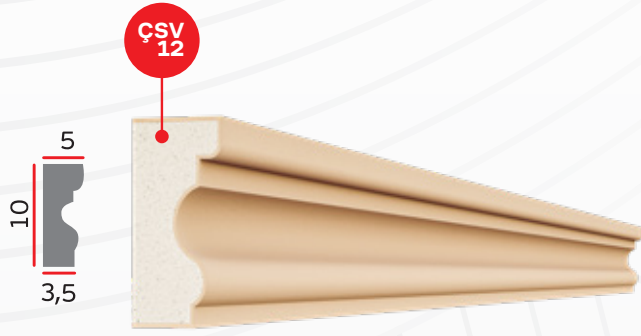

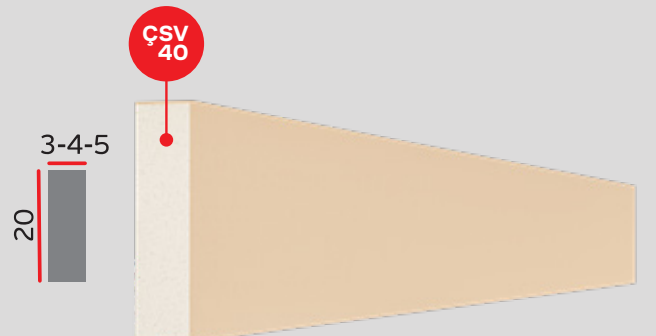
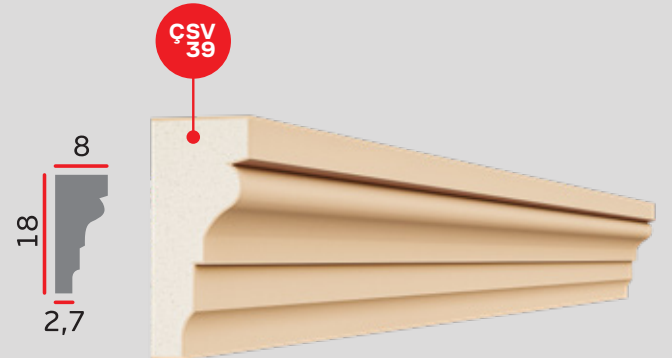
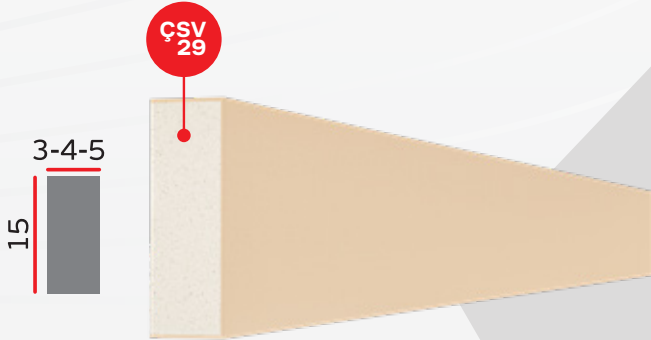

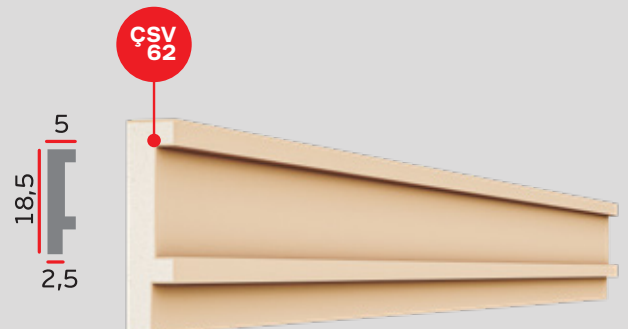
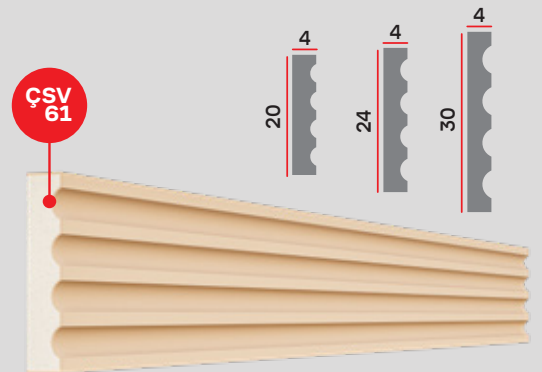

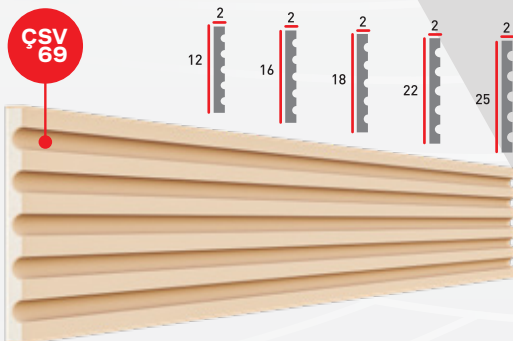
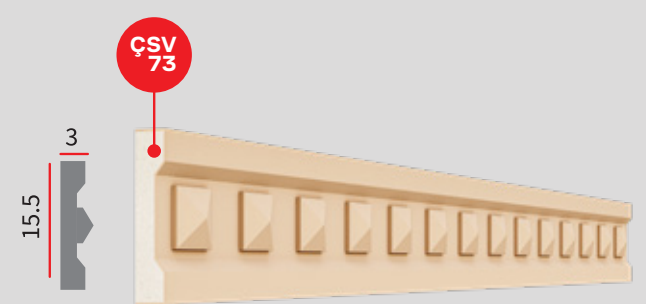

XPS hammaddeden üretilmektedir.
Bu ürünü ÇPY-28 ürünü ile kemer takımı yapabilirsiniz.



XPS hammaddeden üretilmektedir.



SÖVE

Door & Window Frame

براويز خارجيه للنوافذ و الأبواب

CSV
86

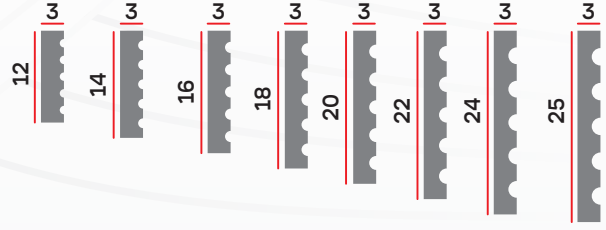

ÇTAÇ 01

7,5
15
4,5



ÇTAÇ 06

6,5
18
5,5



ÇTAÇ 02

11,5
15
4



ÇTAÇ 07

8
16
6



ÇTAÇ 03

9
15
4



ÇTAÇ 08

11,5
15
4



ÇTAÇ 04

9
16,5
4



ÇTAÇ 09

8
15
3,5

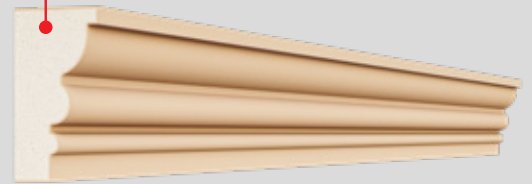

ÇTAÇ 05

9
19,5
5



ÇTAÇ 10

10
16
4

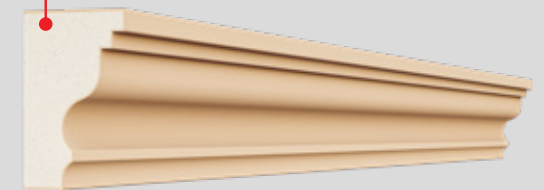

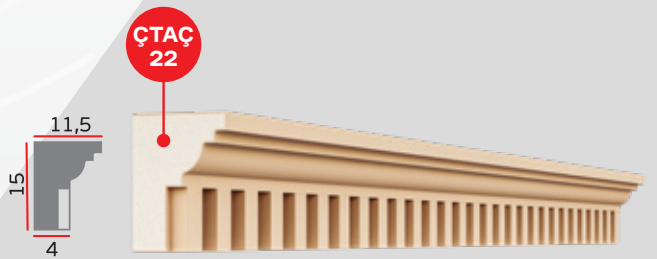
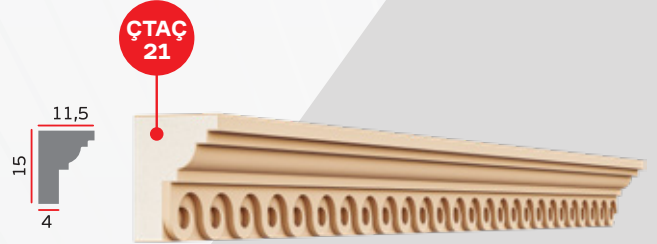
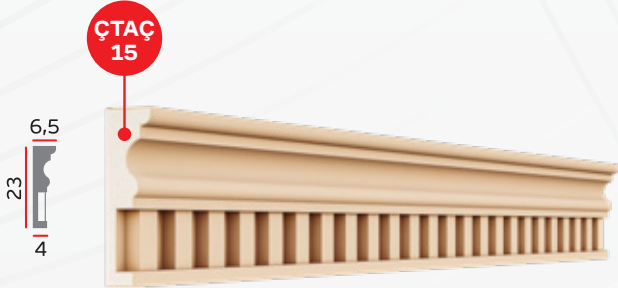

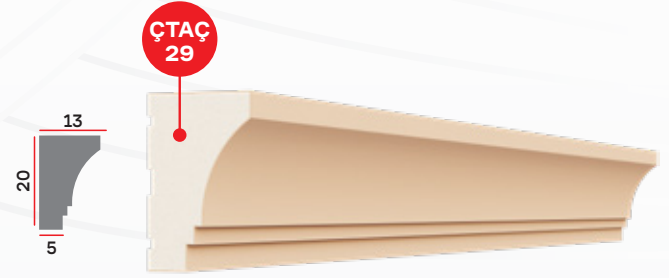

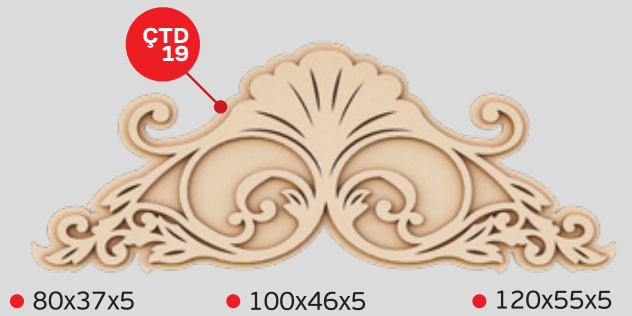
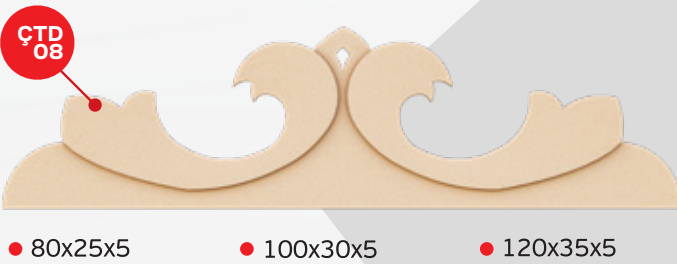
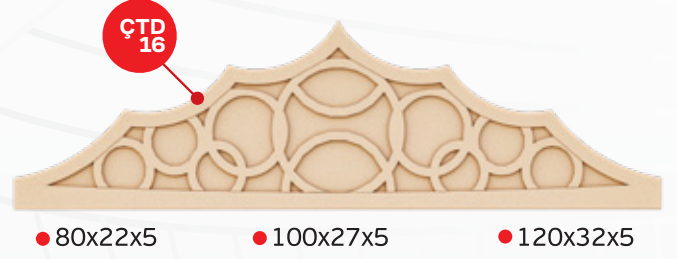



ÇTD
21

- 100x35x5
- 120x42x5



ÇTD
26

- 120x35x6
- 150x40x7
- 200x60x10



ÇTD
22

- 150x50x7
- 200x50x7



ÇTD
27

- 120x32x8
- 150x40x8
- 200x50x8



ÇTD
23

- 120x40x8
- 150x50x8
- 200x50x8
- 310x80x10

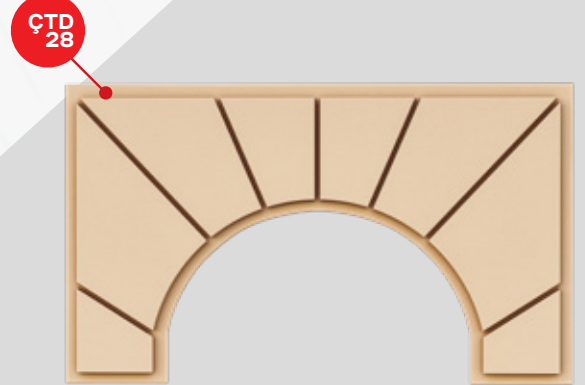

ÇTD
28

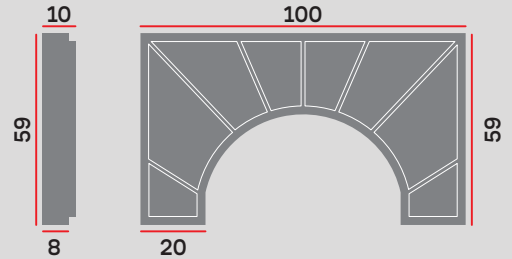

ÇTD
24

- 120x32x7,5
- 150x40x7,5
- 200x50x7,5



ÇTD
25

- 120x32x7,5
- 150x40x7,5
- 200x50x7,5

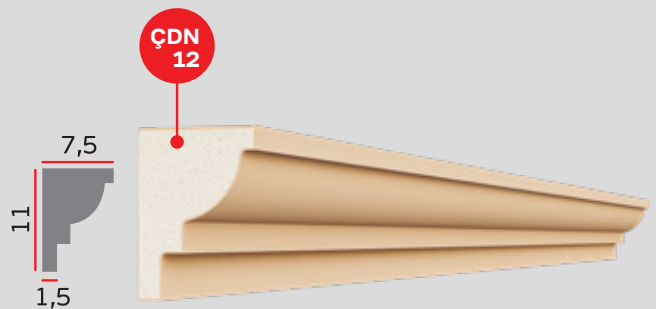
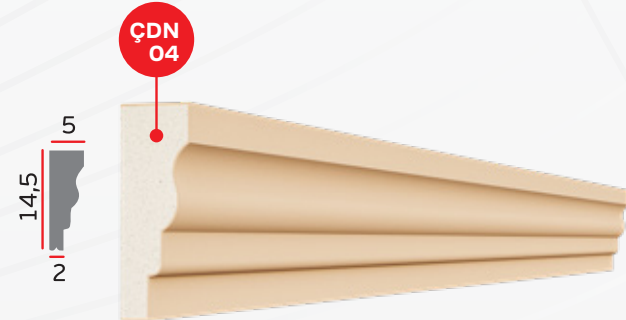
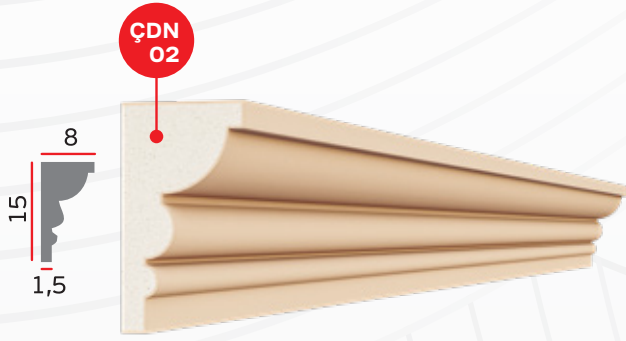

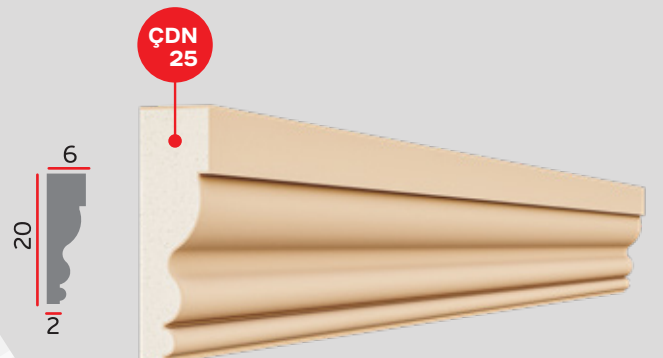
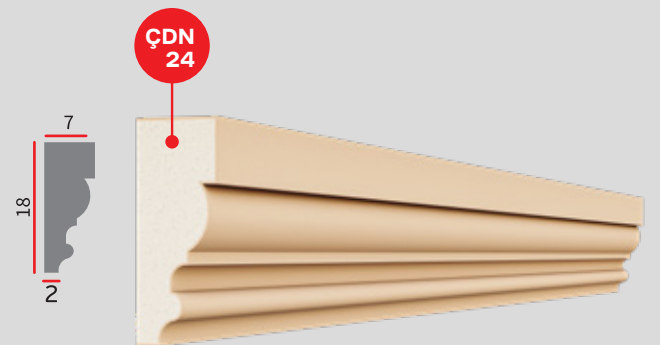
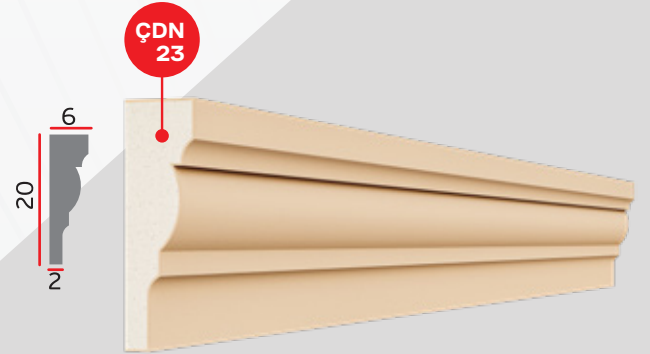
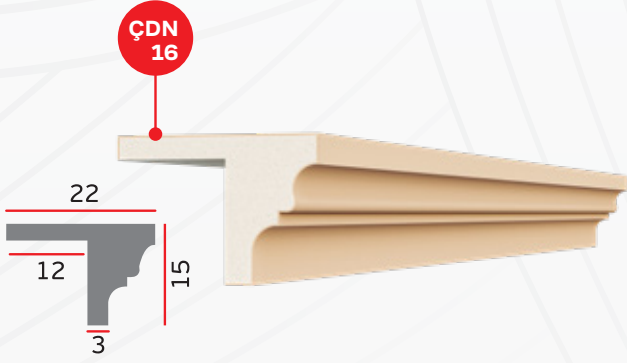

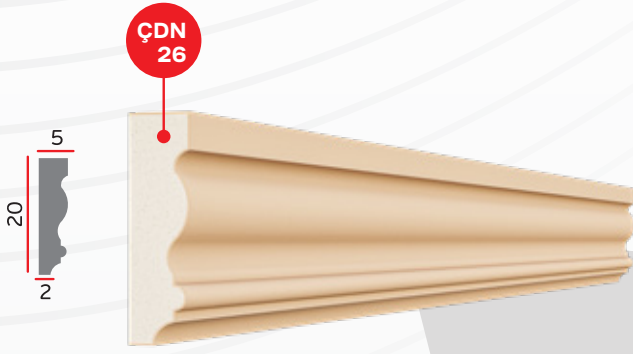

ÇKS 01

30
2
6



ÇKS 07

22
4
8



ÇKS 02

30
5
19

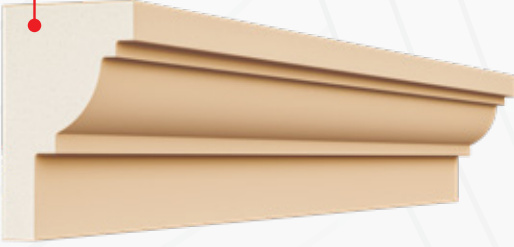

ÇKS 08

24,5
2,5
7,5



ÇKS 04

25
2
15



ÇKS 10

35
2
20

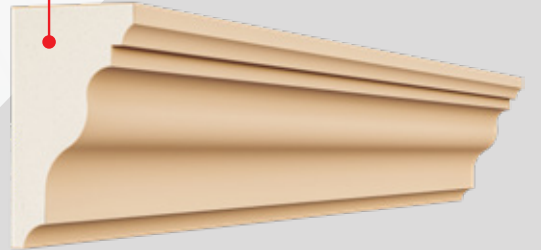

ÇKS 05

24,5
1,5
7



ÇKS 11

35
3
25

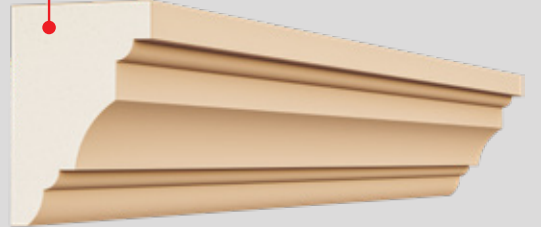

ÇKS 06

35
5
18

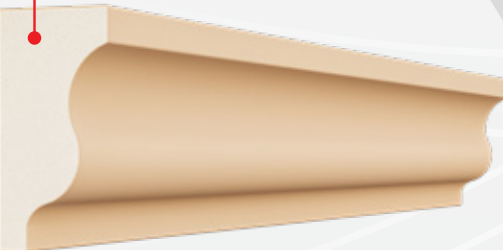

ÇKS 12

22
4
8

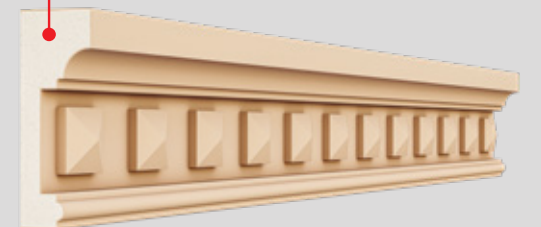

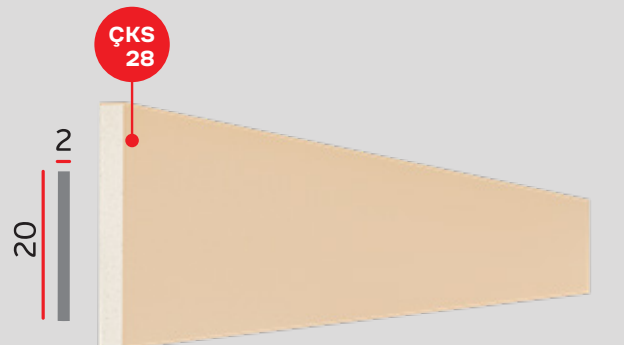
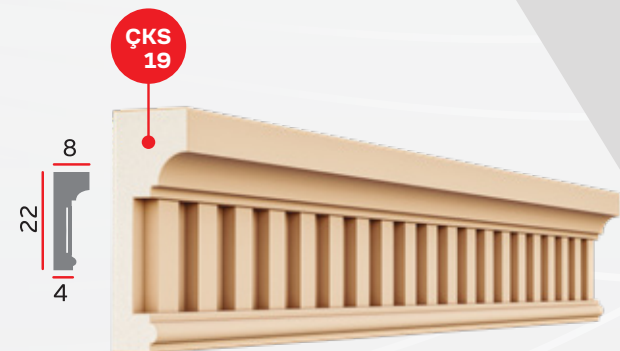
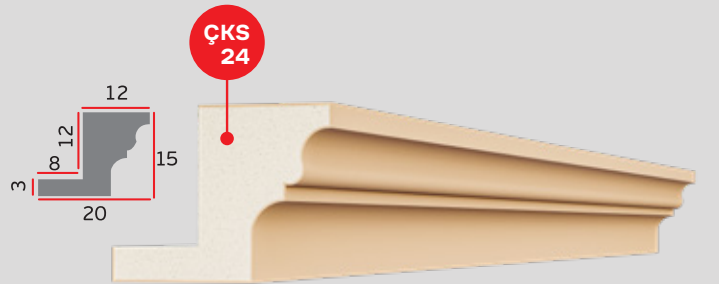
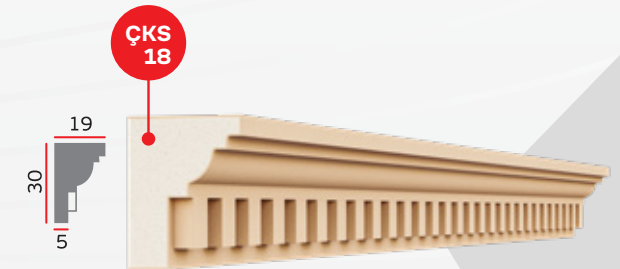
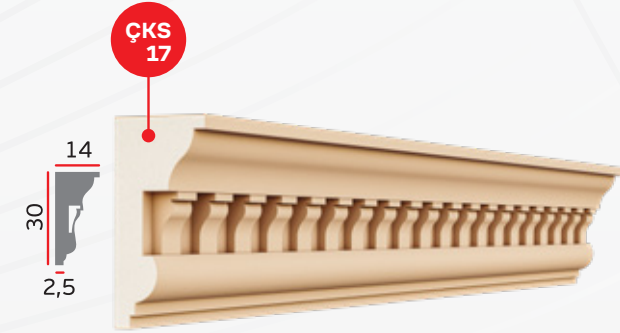
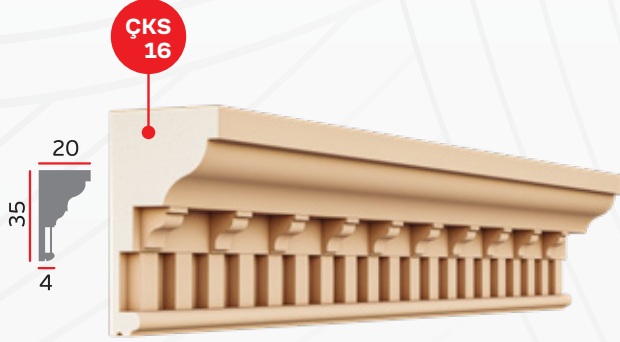

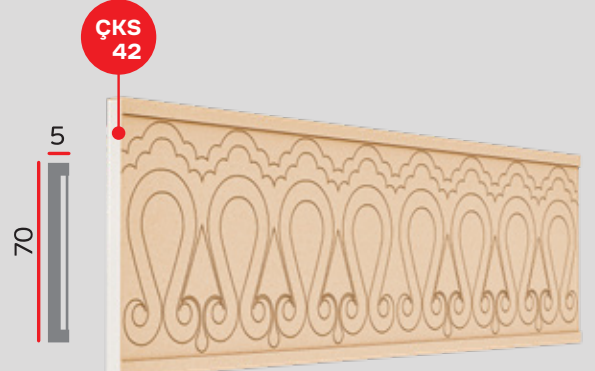
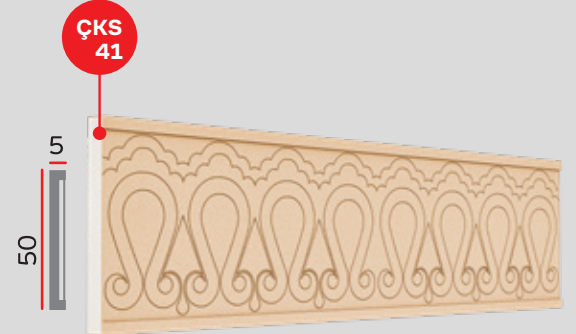
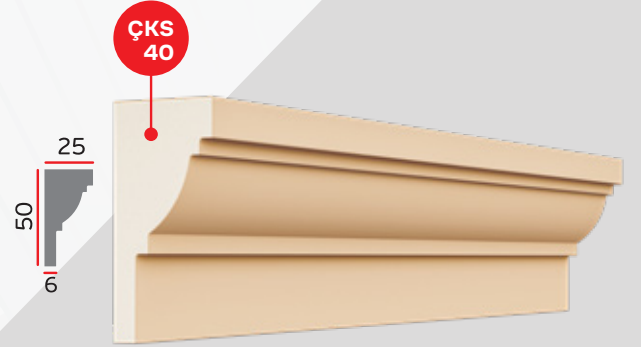

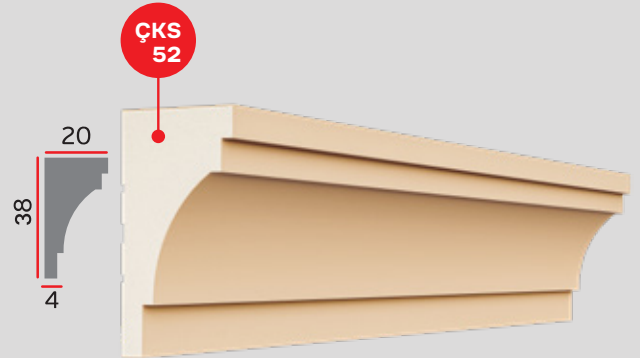
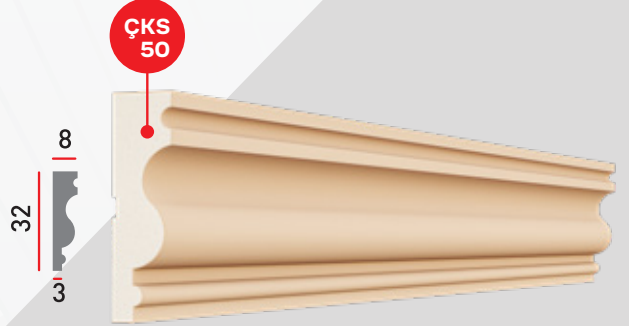
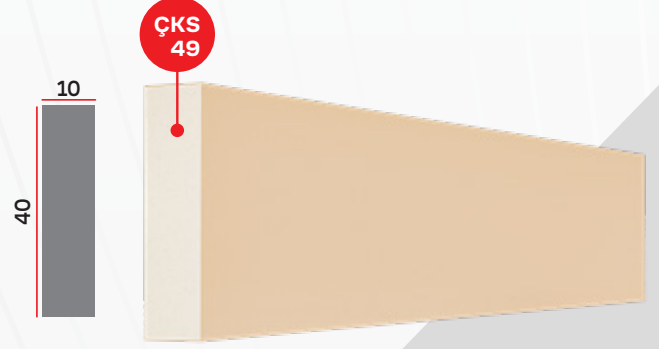

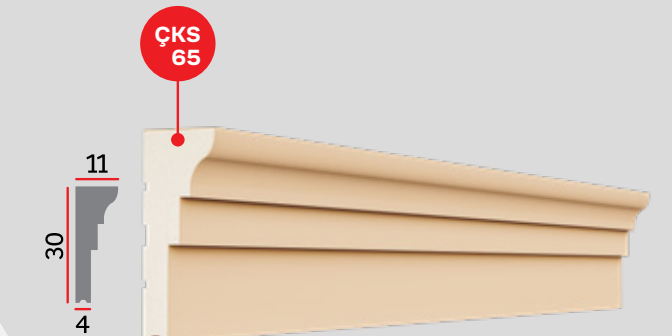
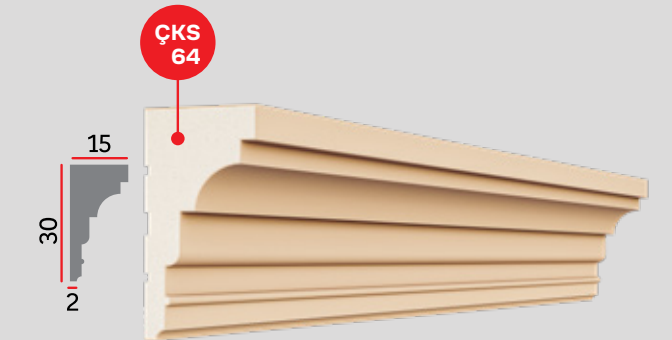
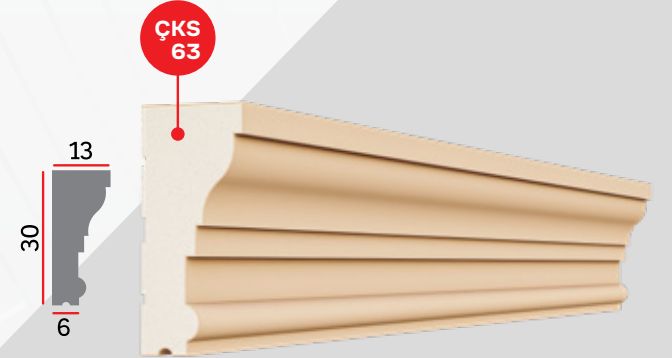
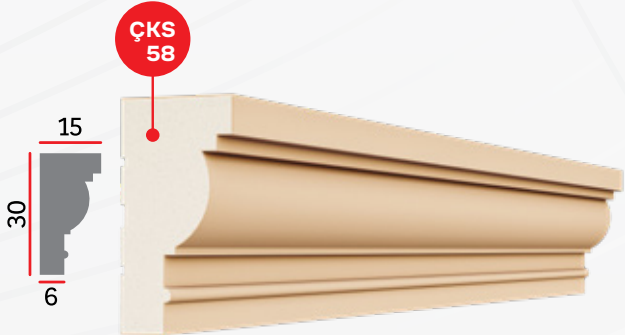
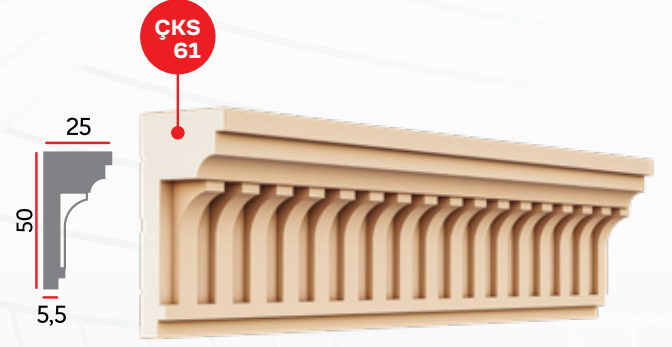

ÇKS
66

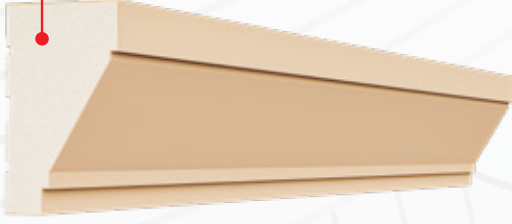
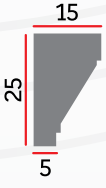

ÇKS
71



ÇKS
67

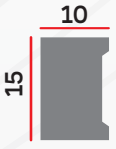

ÇKS
72

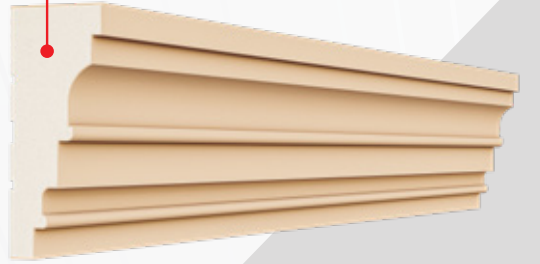

ÇKS
68



ÇKS
73

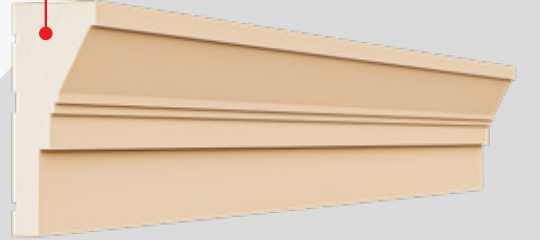

ÇKS
69



ÇKS
74

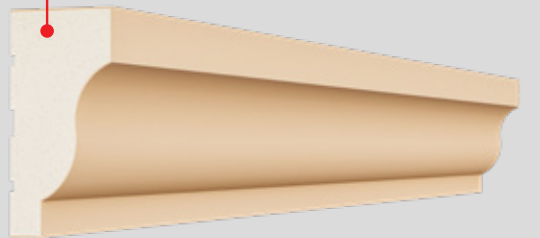

ÇKS
70

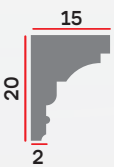

ÇKS
75

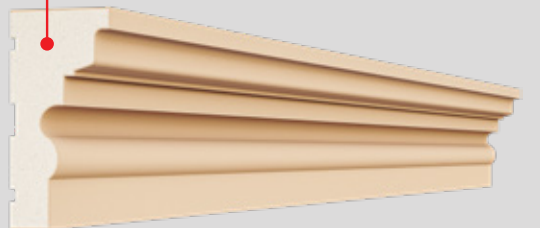

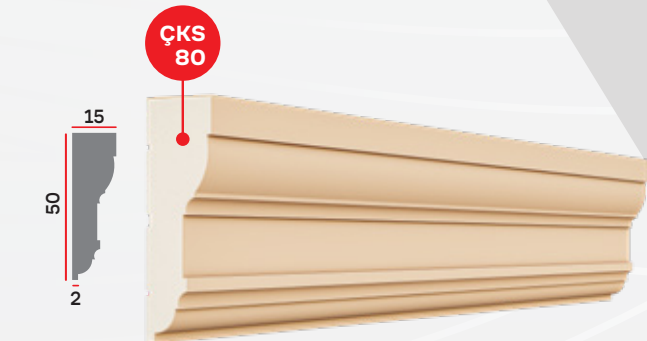
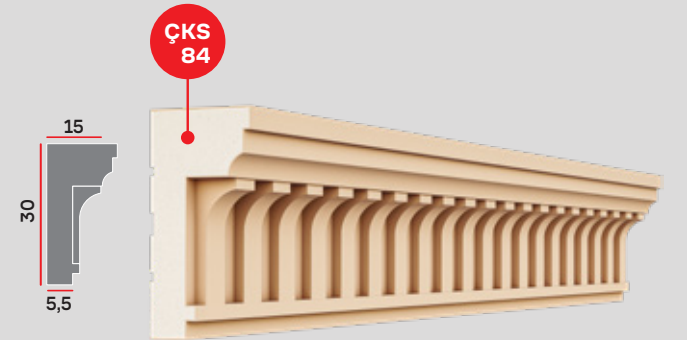
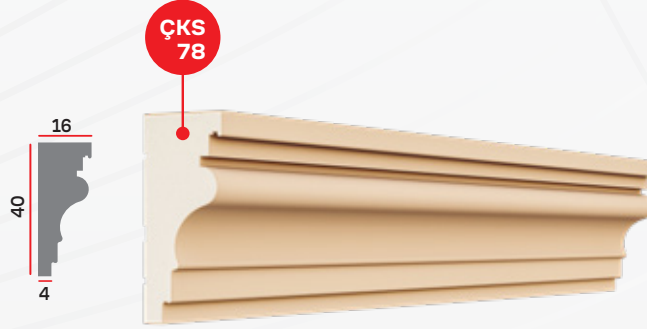
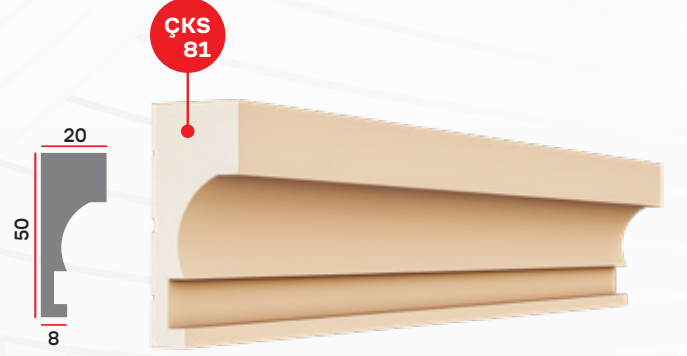
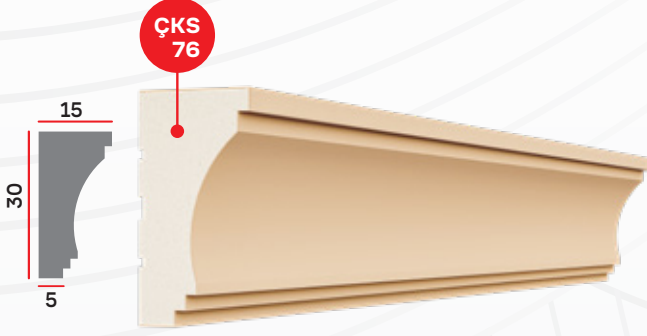

HARPUŐTA

Cover Fence

غطاء السياج

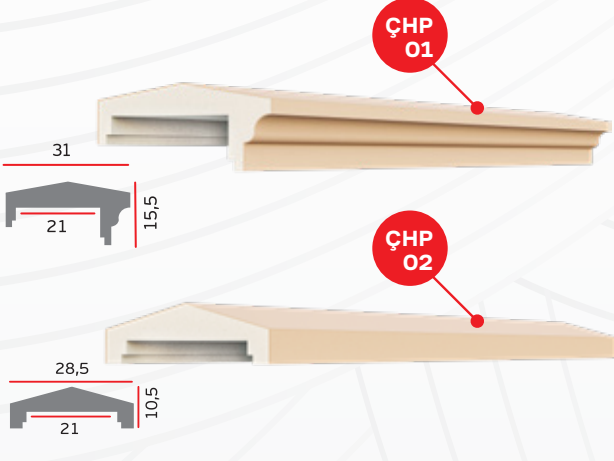

Window Corner Decor

ديكورات زوايا النافذة

YUVARLAK PENCERE

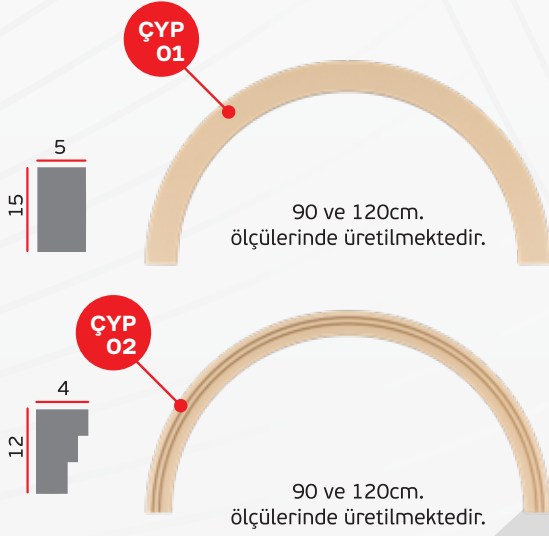

BALUSTRAT



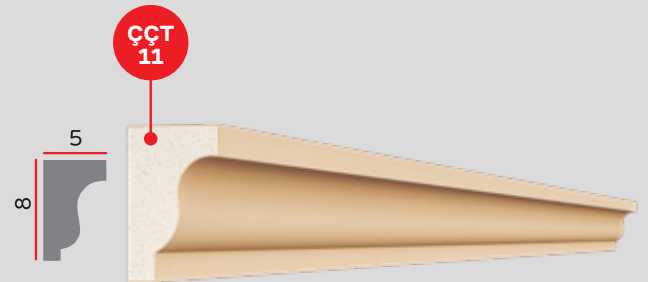



XPS hammaddeden üretilmektedir.

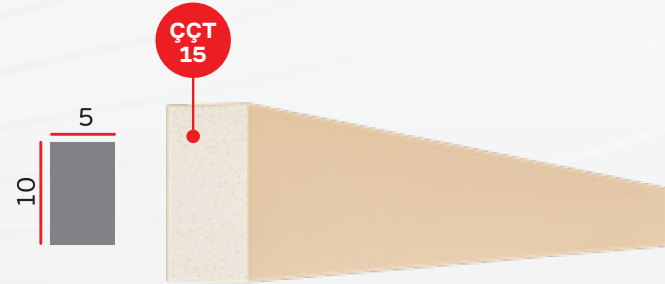

XPS hammaddeden üretilmektedir.



XPS hammaddeden üretilmektedir.



XPS hammaddeden üretilmektedir.



XPS hammaddeden üretilmektedir.

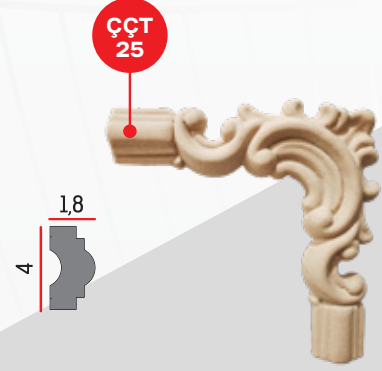

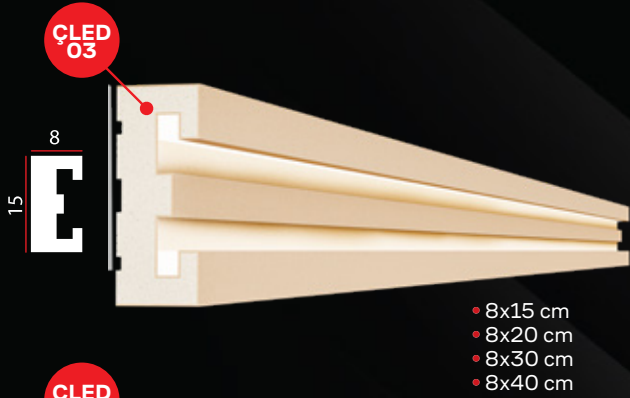
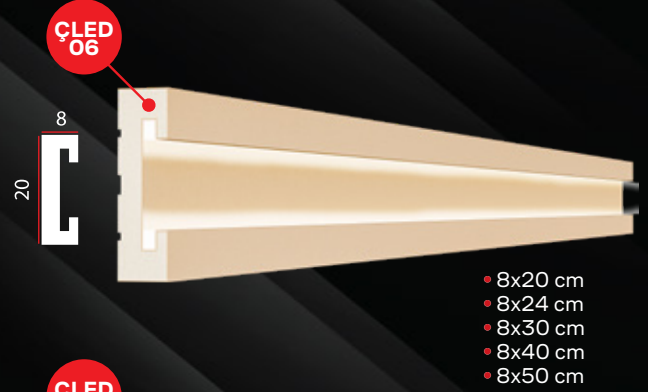
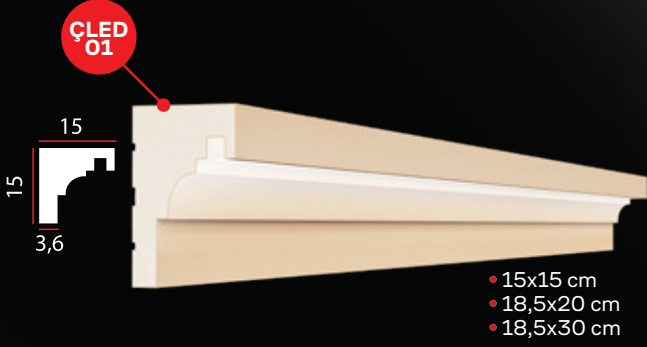



- 10x15 cm
- 15x25 cm

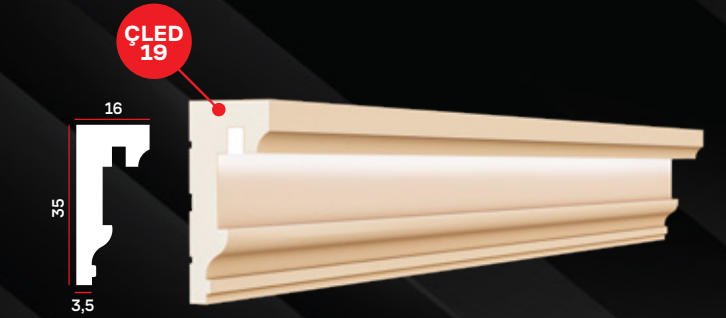
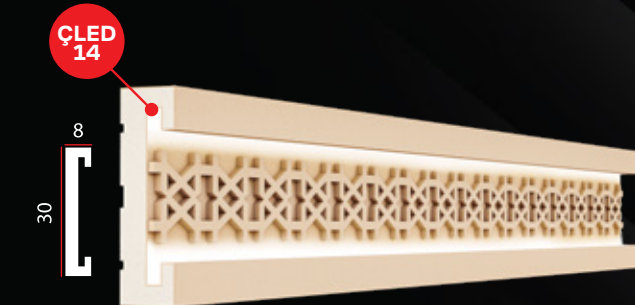

- 8x30 cm
- 8x40 cm



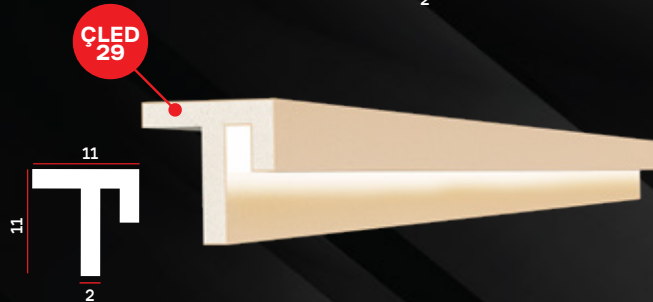
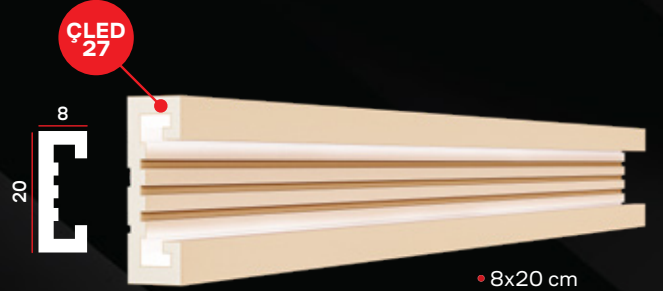
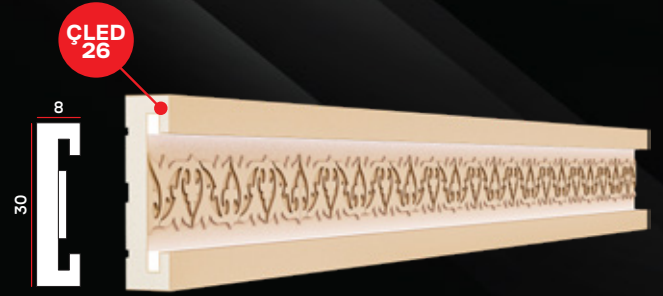
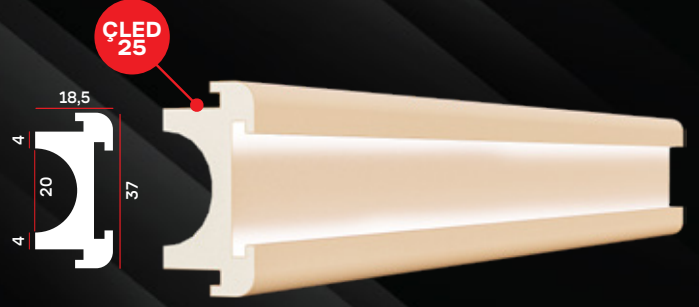
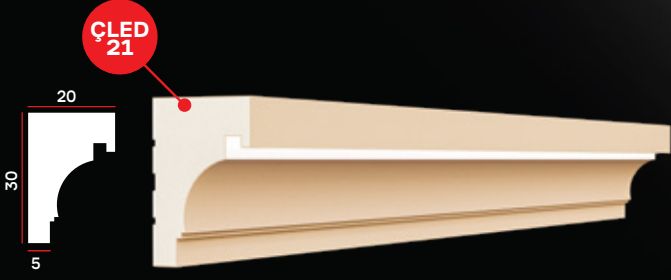

- 8x20 cm
- 10x30 cm
- 12x40 cm

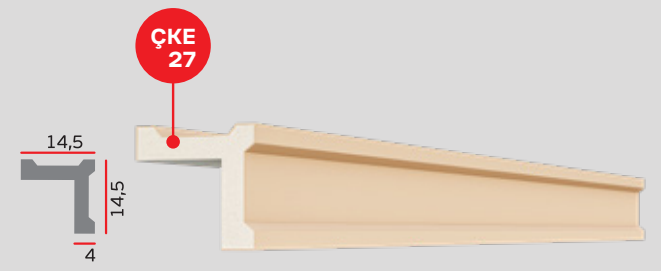

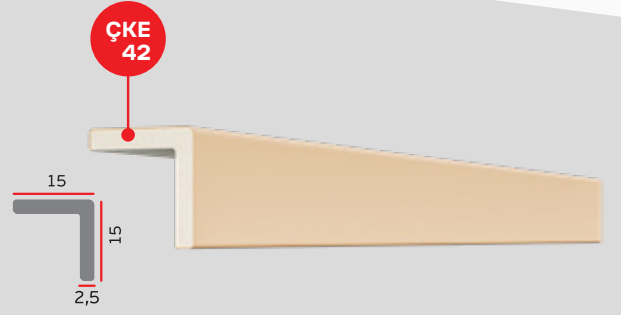

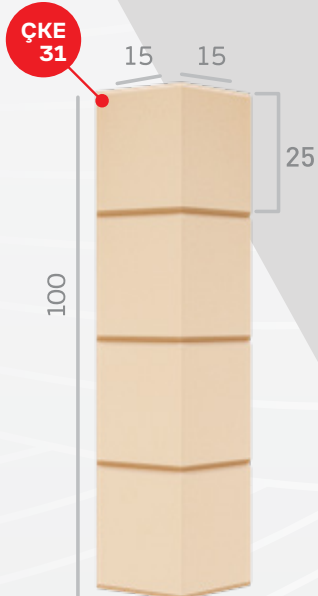
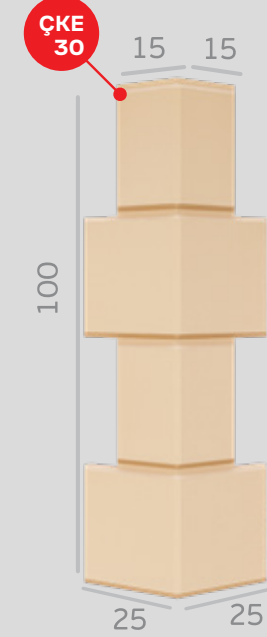
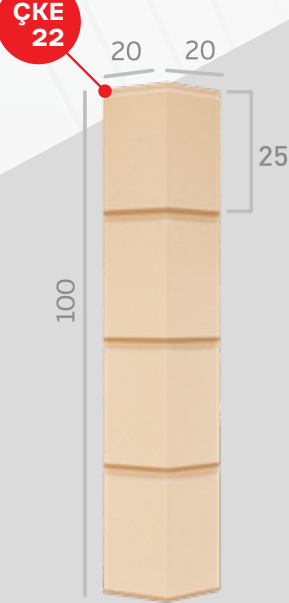
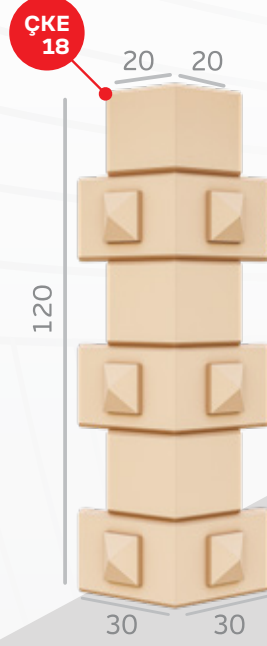
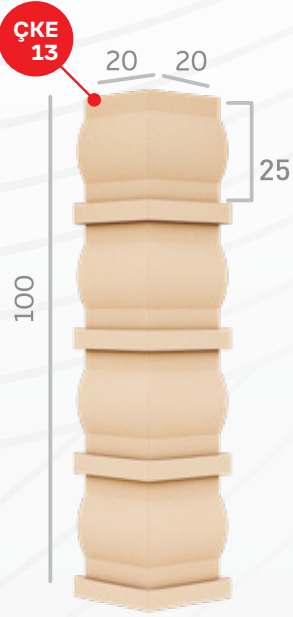

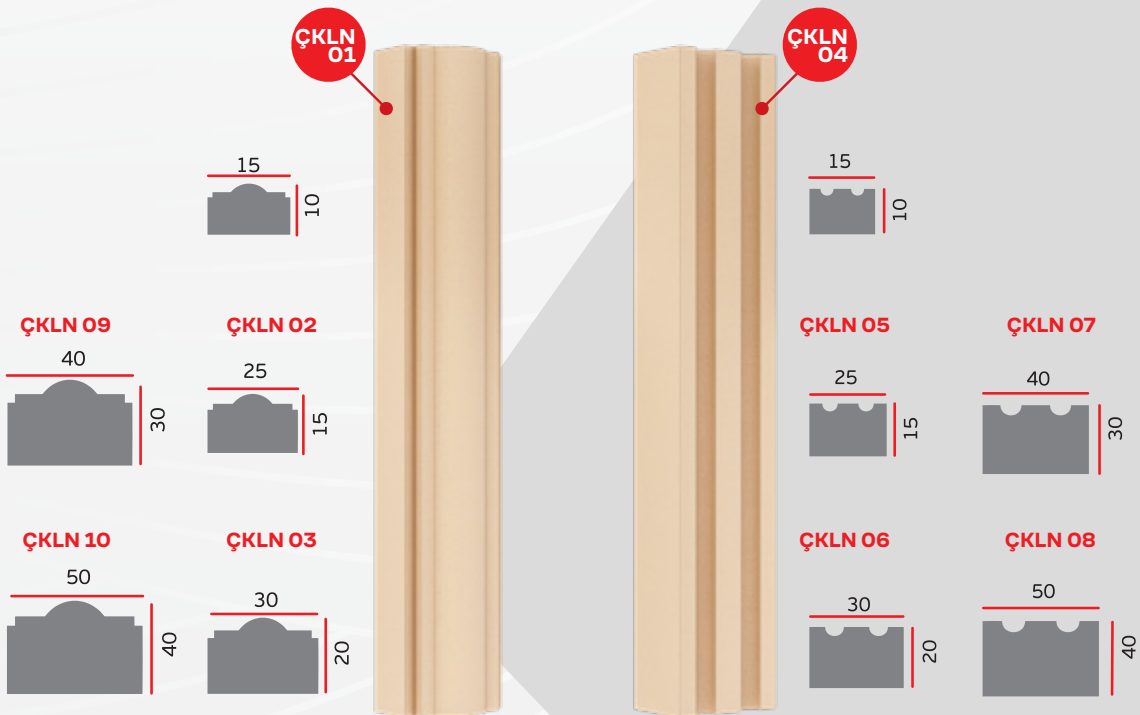
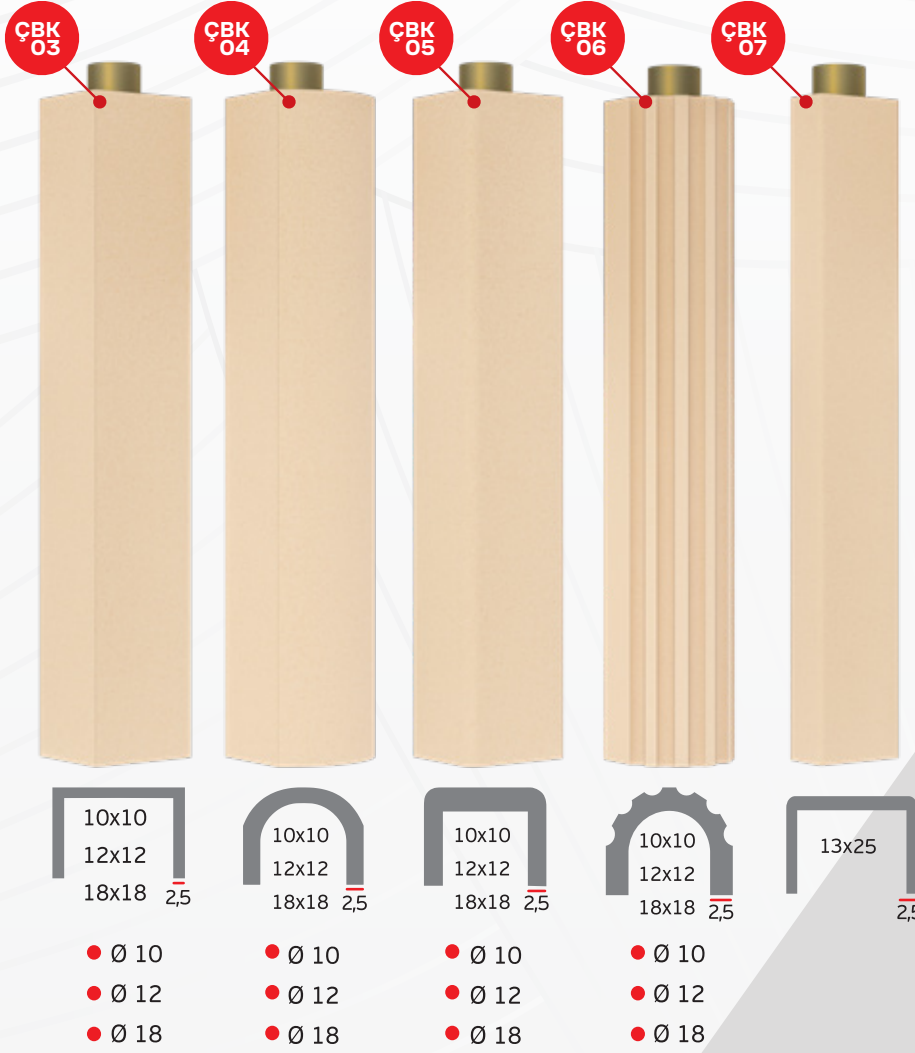

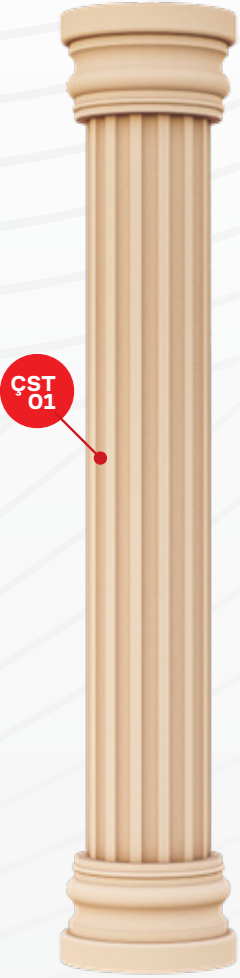

ÇST 01



ÇST 02

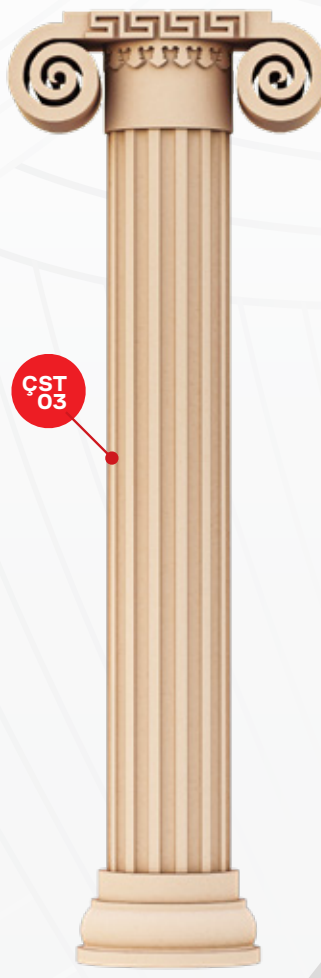

ÇST 03

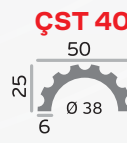

ÇST 06

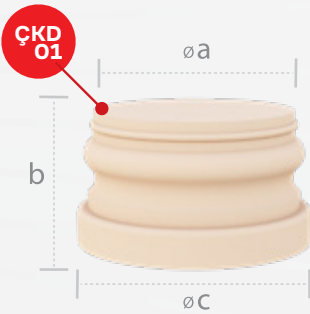
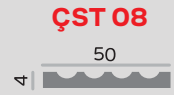

ÇKD 01

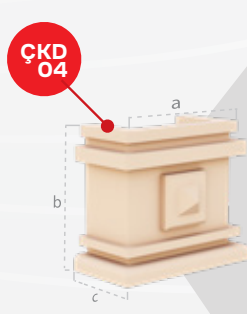

ÇKD 04

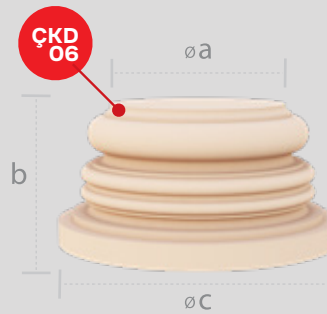

ÇKD 06

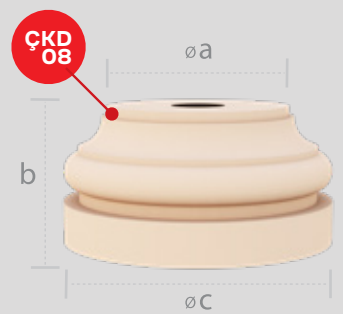

ÇKD 08

ÇKD 01	øa:22 b:25 øc:30	ÇKD 03	øa:42 b:25 øc:50	ÇKD 135	øa: 17 b: 25 øc: 25
ÇKD 02	øa:32 b:25 øc:40	ÇKD 88	øa:52 b:25 øc:60	ÇKD 20	a:22 b:40 c:11
				ÇKD 04	a:32 b:40 c:16
				ÇKD 05	a:42 b:40 c:21
				ÇKD 89	a:52 b:40 c:26

ÇKD 06	øa:22 b:25 øc:30	ÇKD 22	øa:42 b:25 øc:50
ÇKD 21	øa:32 b:25 øc:40		

ÇKD 08	øa:22 b:25 øc:30	ÇKD 26	øa:42 b:25 øc:50
ÇKD 25	øa:32 b:25 øc:40	ÇKD 90	øa:52 b:25 øc:60

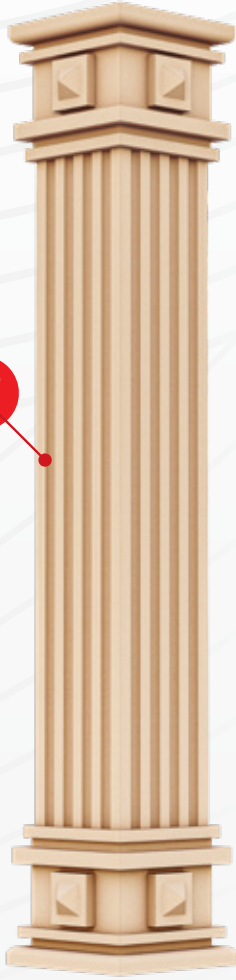

ÇST 15

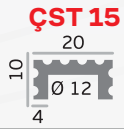

ÇST 15

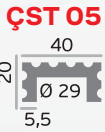

ÇST 05

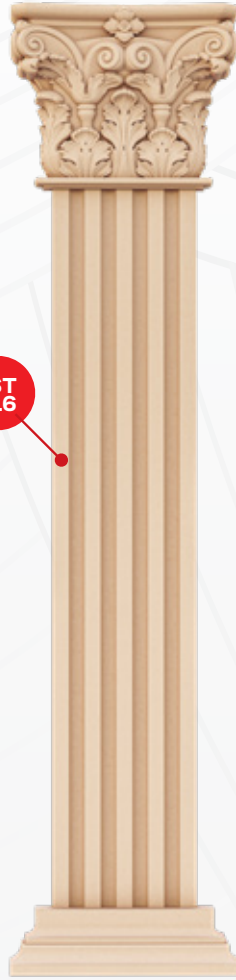

ÇST 16



ÇST 16



ÇST 17



ÇST 18



ÇST 18



ÇST 62



ÇST 22



ÇST 22

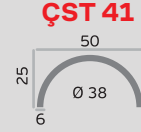

ÇST 41

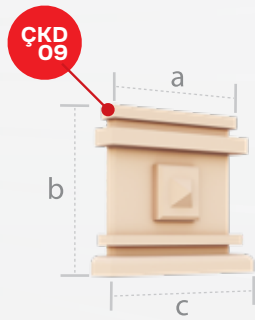

ÇKD 09

ÇKD 09 a:33
b:40
c:40

ÇKD 10 a:43
b:40
c:50

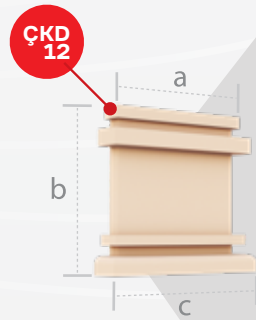

ÇKD 12

ÇKD 12 a:33
b:40
c:40

ÇKD 13 a:43
b:40
c:50

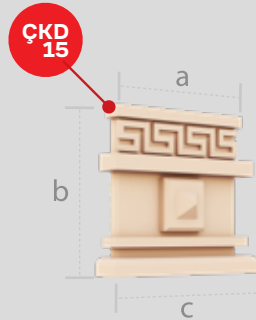

ÇKD 15

ÇKD 15 a:33
b:40
c:40

ÇKD 16 a:43
b:40
c:50

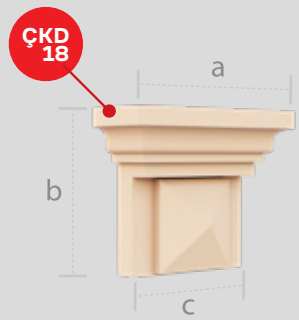

ÇKD 18

ÇKD 18 a:48
b:25
c:33

ÇKD 29 a:58
b:25
c:43

ÇKD 11 a:53
b:40
c:60

ÇKD 138 a:23
b:30
c:40

ÇKD 14 a:53
b:40
c:60

ÇKD 134 a:23
b:40
c:30

ÇKD 17 a:53
b:40
c:60

ÇKD 139 a:23
b:40
c:30

ÇKD 30 a:68
b:25
c:53

ÇKD 137 a:38
b:25
c:23



ÇST 23

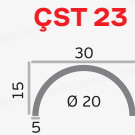

ÇST 23



ÇST 24



ÇST 24

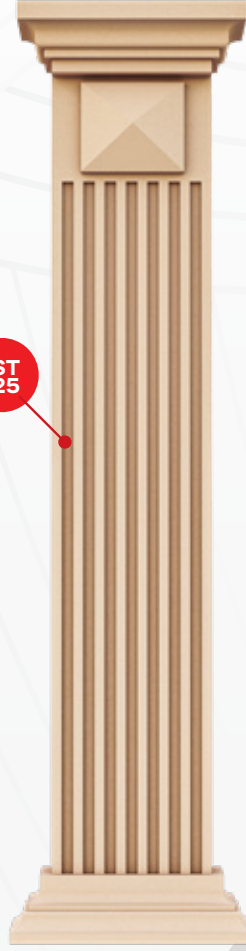

ÇST 25



ÇST 25

ÇST 26



ÇST 37



ÇST 37

ÇST 38



ÇST 27



ÇST 65



ÇST 39



ÇST 46

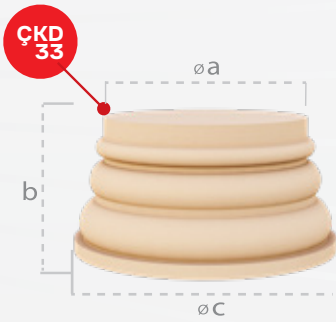

ÇKD 33

ÇKD 33 øa:22
b:15
øc:30



ÇKD 36

ÇKD 36 øa:22
b:15
øc:30

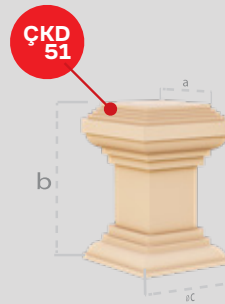

ÇKD 51

ÇKD 51 a:22
b:50
c:32



ÇKD 57

ÇKD 57 a:32
b:15
c:45

ÇKD 35 øa:42
b:15
øc:50

ÇKD 91 øa:52
b:15
øc:60

ÇKD 38 øa:42
b:15
øc:50

ÇKD 92 øa:52
b:15
øc:60

ÇKD 53 a:42
b:100
c:52

ÇKD 52 a:32
b:80
c:42

ÇKD 58 a:42
b:15
c:55

ÇKD 59 a:52
b:15
c:65



ÇST 47

ÇST 47

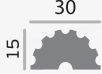

ÇST 48

ÇST 48

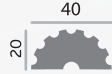

ÇST 49

ÇST 49



ÇST 53

ÇST 53



ÇST 55



ÇST 54

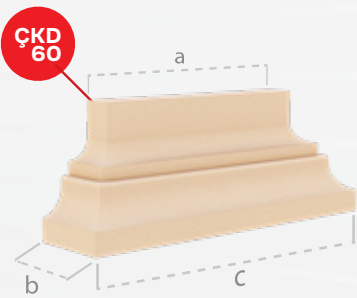

ÇKD 60



ÇKD 66

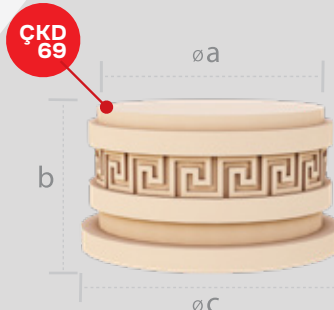

ÇKD 69

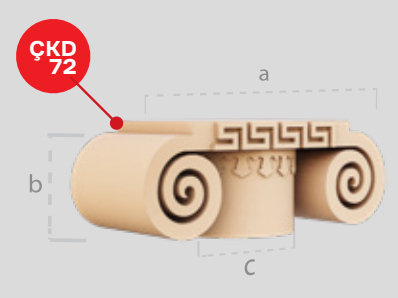

ÇKD 72

ÇKD 60	a:30 b:15 c:42	ÇKD 62	a:50 b:15 c:62
ÇKD 61	a:40 b:15 c:52		

ÇKD 66	a:32 b:30 c:32	ÇKD 68	a:52 b:30 c:52
ÇKD 67	a:42 b:30 c:42	ÇKD 136	a:22 b:30 c:22

ÇKD 69	Øa:22 b:32 Øc:30	ÇKD 71	Øa:52 b:32 Øc:60
ÇKD 70	Øa:42 b:32 Øc:50	ÇKD 114	Øa:32 b:32 Øc:40

ÇKD 72	a:54 b:19,5 c:22	ÇKD 74	a:103 b:37,5 c:42
ÇKD 73	a:78,5 b:28,5 c:32		

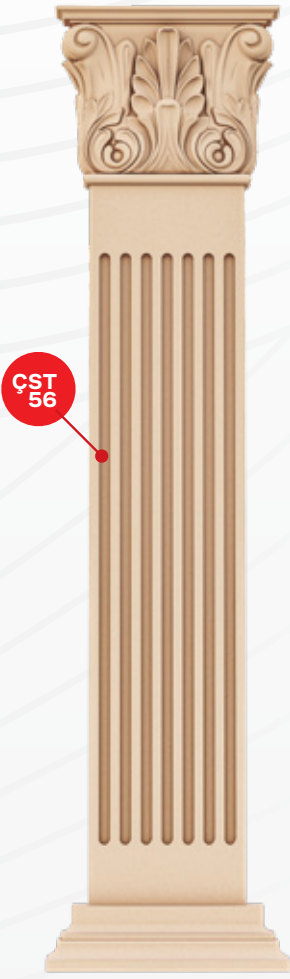

ÇST 56

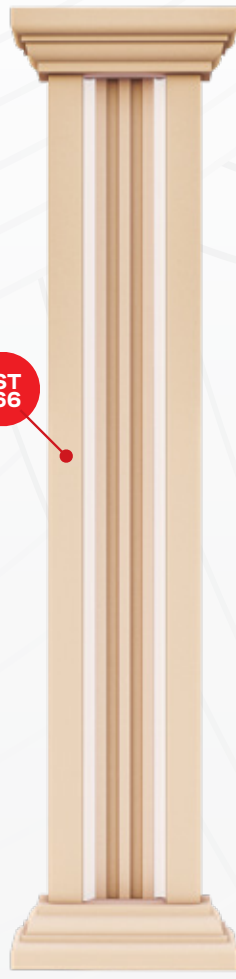
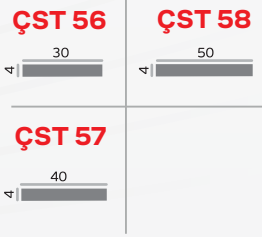

ÇST 66

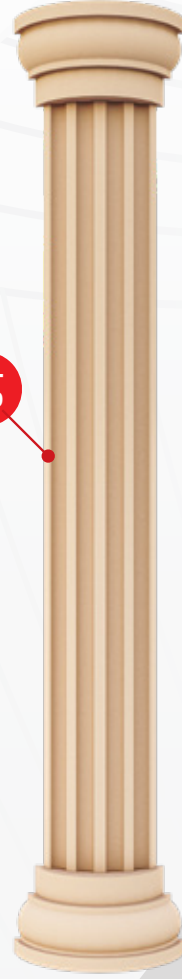
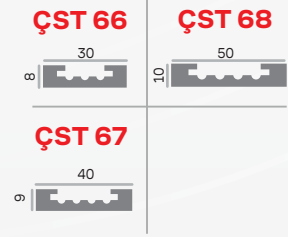

ÇST 69

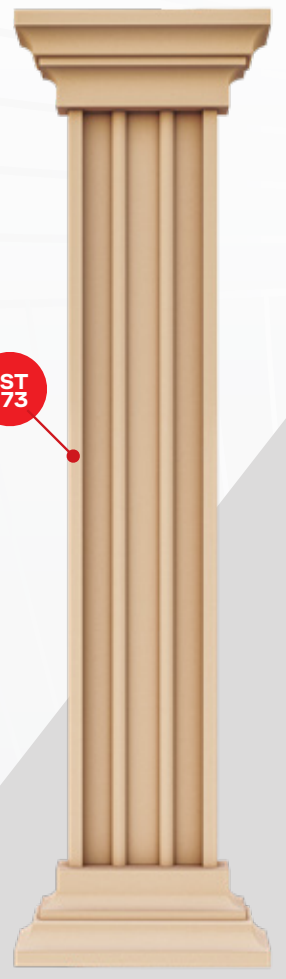
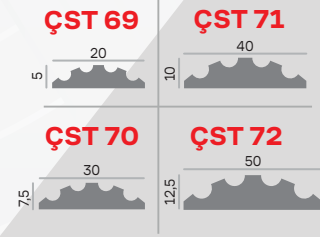

ÇST 73

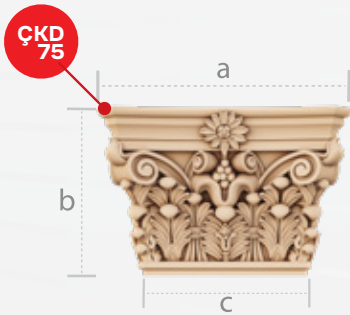
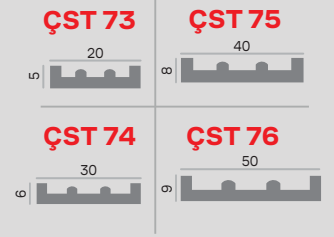

ÇKD 75

ÇKD 75	a:37 b:40 c:22	ÇKD 77	a:70 b:50 c:42
ÇKD 76	a:53 b:50 c:32	ÇKD 78	a:87 b:50 c:52



ÇKD 81

ÇKD 81	a:44 b:40 c:22	ÇKD 83	a:60 b:50 c:42
ÇKD 82	a:46 b:50 c:32	ÇKD 84	a:95 b:50 c:52

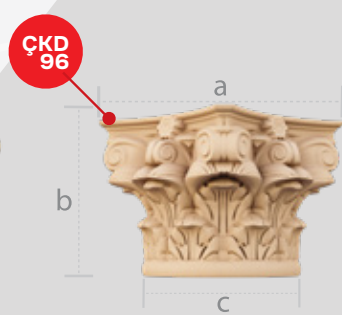

ÇKD 96

ÇKD 96	a:51 b:50 c:32	ÇKD 98	a:84 b:50 c:52
ÇKD 97	a:69 b:50 c:42		



ÇKD 99

ÇKD 99	a:66 b:50 c:32	ÇKD 101	a:79 b:50 c:52
ÇKD 100	a:70 b:50 c:42		

CKD 102

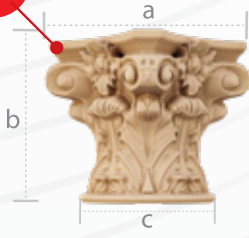

CKD 102 a:52
b:50
c:32

CKD 104 a:82
b:50
c:52

CKD 103 a:65
b:50
c:42

CKD 105

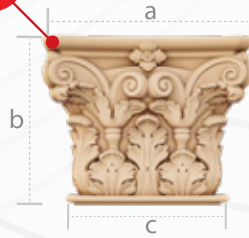

CKD 105 a:50
b:50
c:35

CKD 107 a:75
b:50
c:55

CKD 106 a:62
b:50
c:45

16,5 cm kalınlığında üretilmektedir.

CKD 108

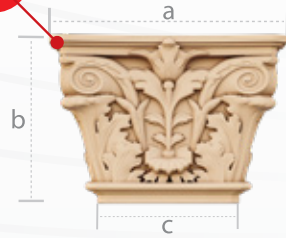

CKD 108 a:56
b:50
c:35

CKD 110 a:90
b:50
c:55

CKD 109 a:72
b:50
c:45

15 cm kalınlığında üretilmektedir.

CKD 111

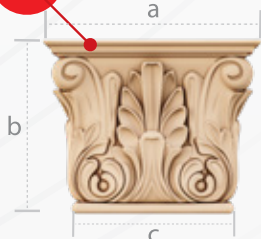

CKD 111 a:50
b:50
c:35

CKD 113 a:77
b:50
c:55

CKD 112 a:62
b:50
c:45

12,5 cm kalınlığında üretilmektedir.

CKD 115

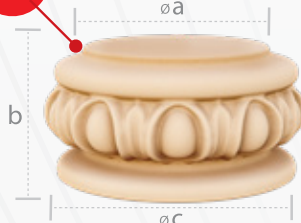

CKD 115 øa:22
b:15
øc:30

CKD 117 øa:42
b:22
øc:56

CKD 116 øa:32
b:15
øc:38

CKD 140 øa:52
b:38,5
øc:78

CKD 118



CKD 118 a:42
b:40
c:22

CKD 120 a:80
b:50
c:42

CKD 119 a:61
b:50
c:32

CKD 121 a:99
b:50
c:52

CKD 122

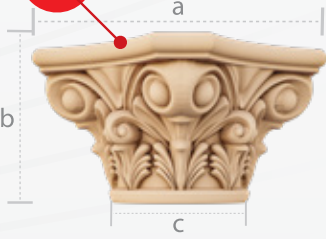

CKD 122 a:48
b:40
c:22

CKD 124 a:91
b:50
c:42

CKD 123 a:70
b:50
c:32

CKD 125 a:112
b:50
c:52

CKD 126

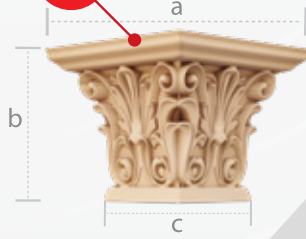

CKD 126 a:49
b:40
c:22

CKD 128 a:94
b:50
c:42

CKD 127 a:72
b:50
c:32

CKD 129 a:116
b:50
c:52

CKD 130

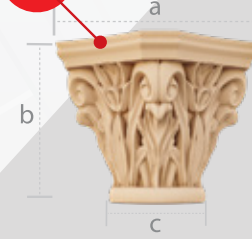

CKD 130 a:47
b:40
c:22

CKD 132 a:90
b:50
c:42

CKD 131 a:69
b:50
c:32

CKD 133 a:111
b:50
c:52

CKD 141

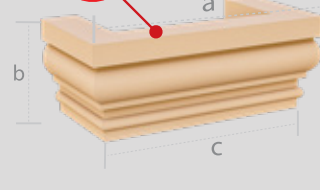

CKD 141 a:30
b:24
c:22

CKD 143 a:50
b:24
c:42

CKD 142 a:40
b:24
c:32

CKD 144 a:60
b:24
c:52

CKD 145

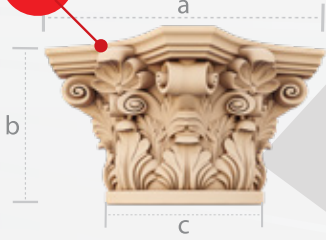

CKD 145 a:34
b:30
c:22

CKD 147 a:64
b:50
c:42

CKD 146 a:49
b:40
c:32

CKD 148 a:80
b:50
c:52

CKD 149

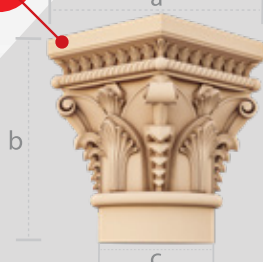

CKD 149 a:31
b:40
c:22

CKD 151 a:59
b:50
c:42

CKD 150 a:45
b:50
c:32

CKD 152 a:74
b:50
c:52

CKD 153

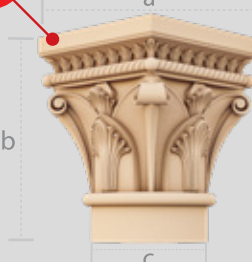

CKD 153 a:31
b:40
c:22

CKD 155 a:59
b:50
c:42

CKD 154 a:45
b:50
c:32

CKD 156 a:74
b:50
c:52

CKD 157

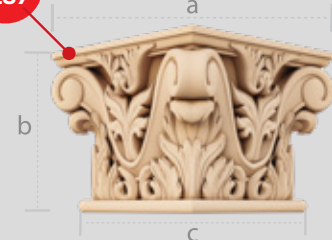

CKD 157 a:30
b:30
c:22

CKD 159 a:58
b:50
c:42

CKD 158 a:44
b:40
c:32

CKD 160 a:72
b:50
c:52

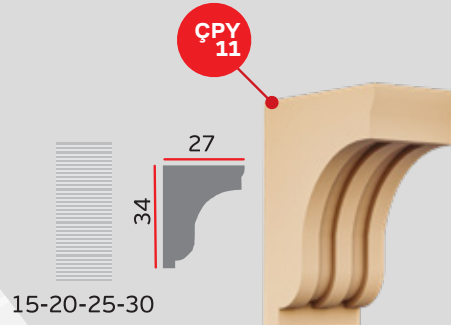
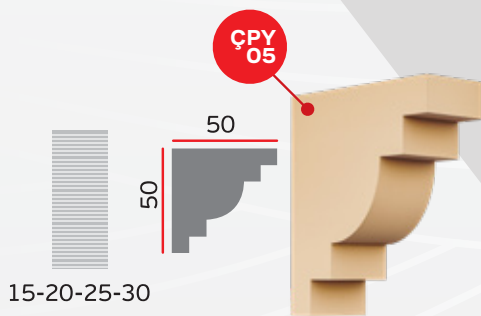
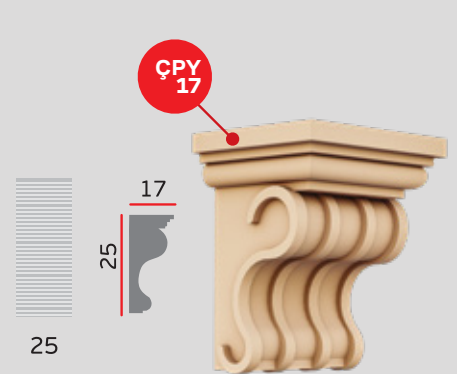
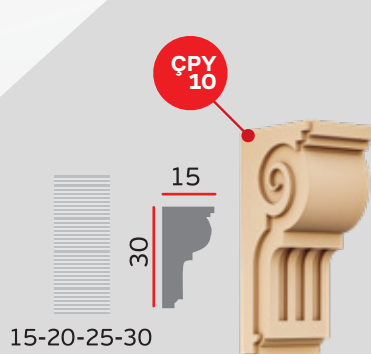
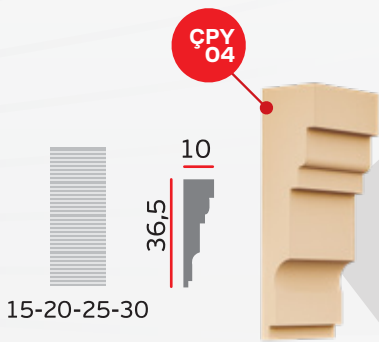
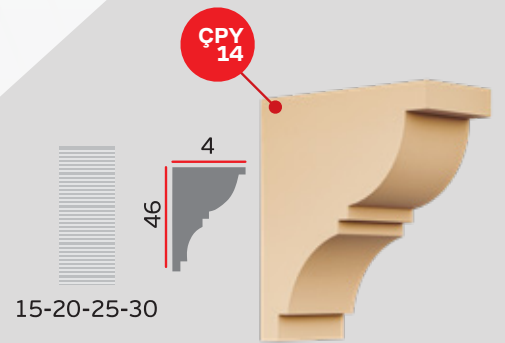
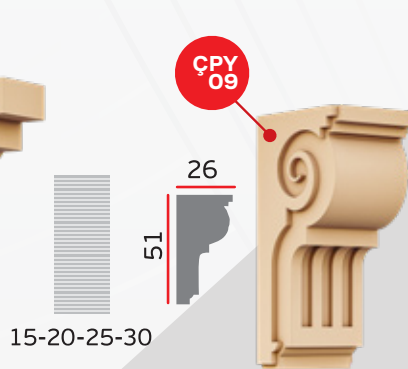
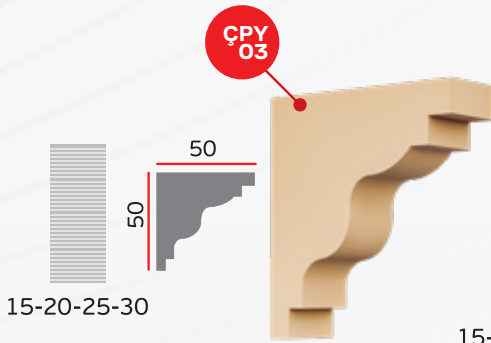
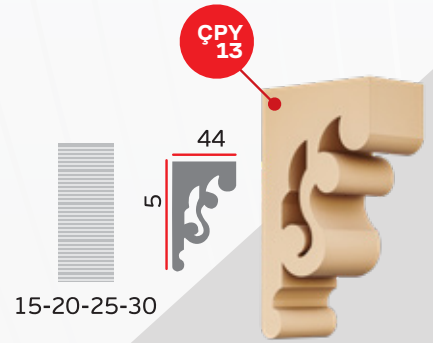
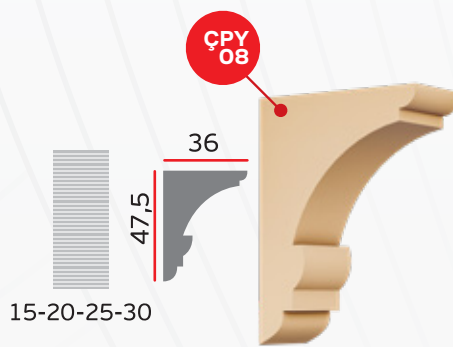
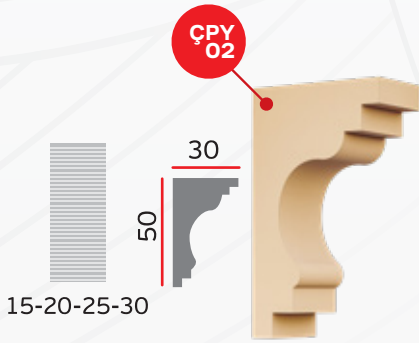
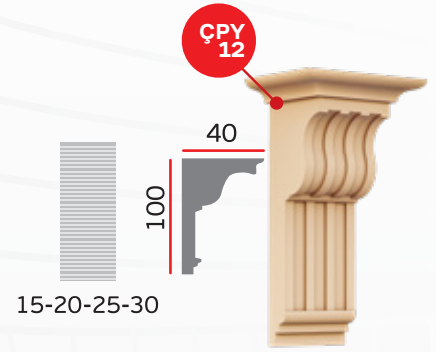
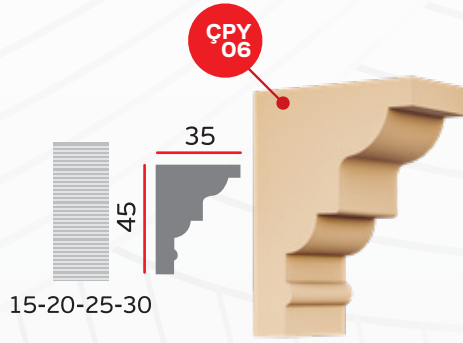
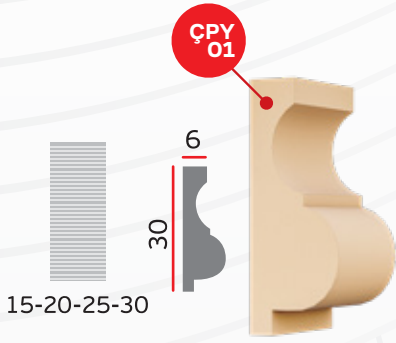

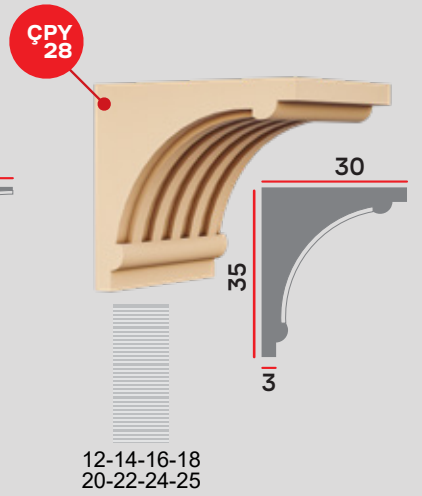
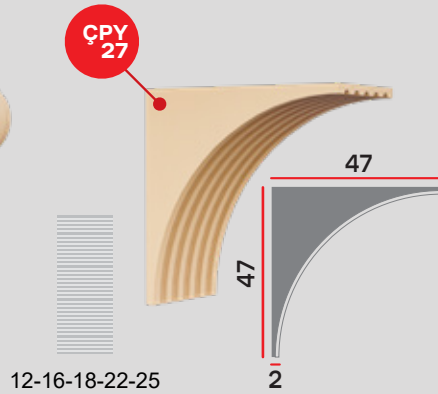
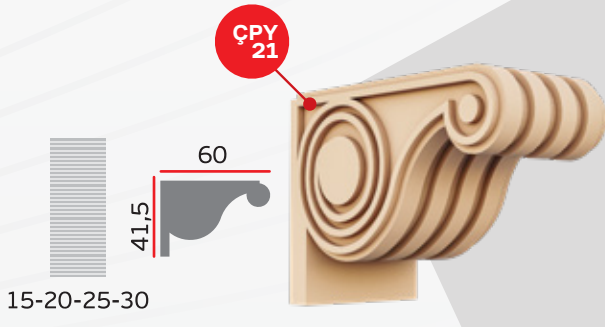
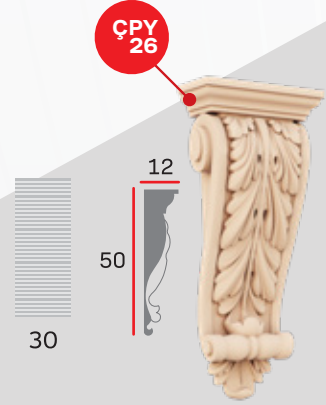
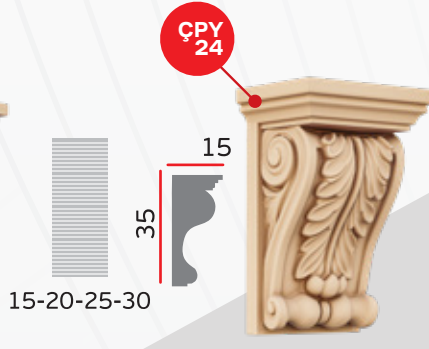
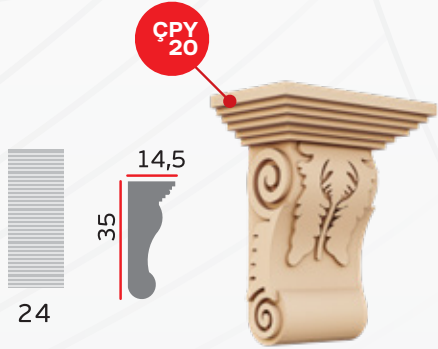
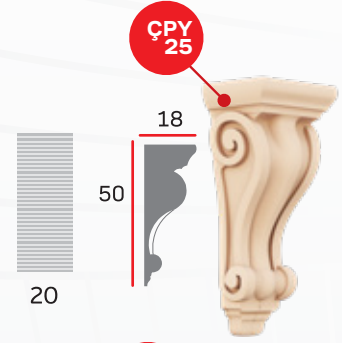
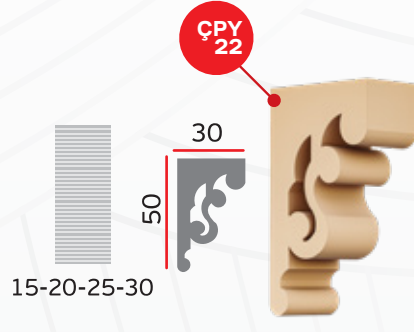
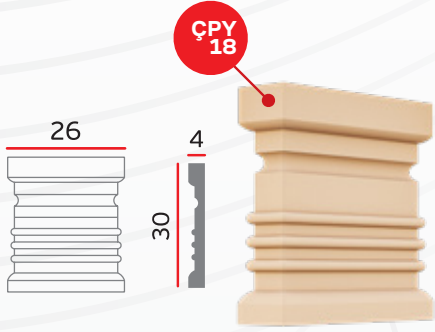

SİZİN İÇİN
ÖZENLE
TASARLADIK

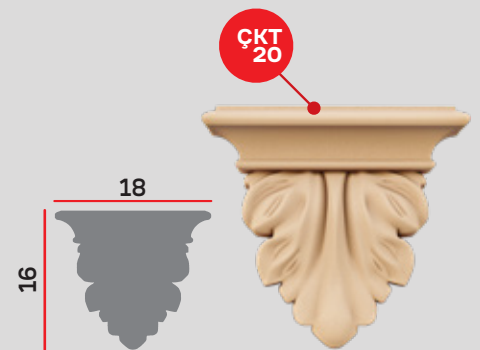
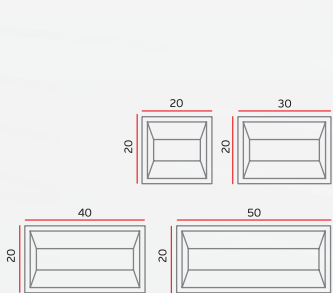
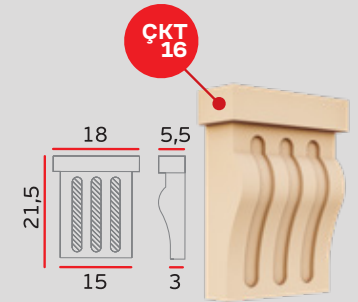
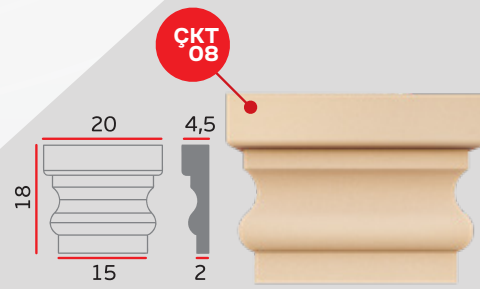
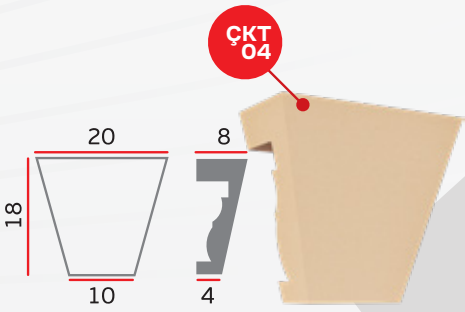
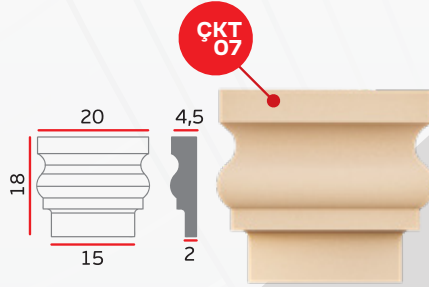
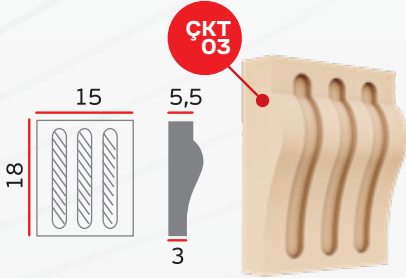
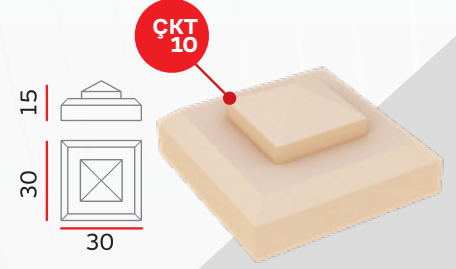
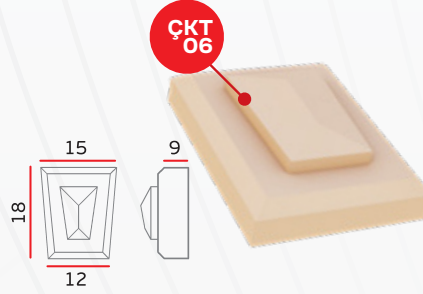
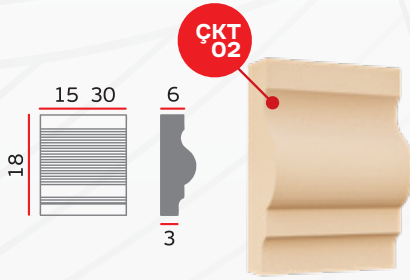
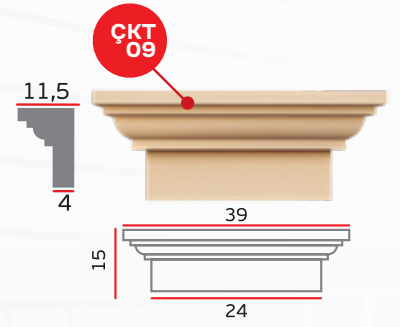
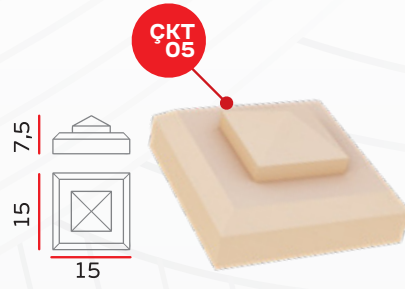
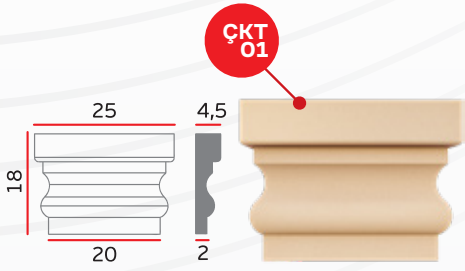

5 cm kalınlığında üretilmektedir.



CRZ 01

50x50x7,5 cm



CRZ 02

50x50x5 cm



CRZ 03

50x50x5 cm



CRZ 04

50x50x6 cm

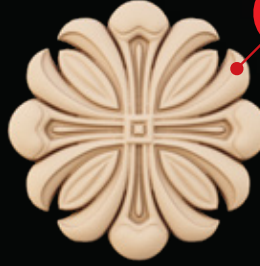

CRZ 05

50x50x6 cm



CRZ 06

50x50x7,5 cm



CRZ 07

75x75x5 cm



CRZ 08

50x50x6 cm

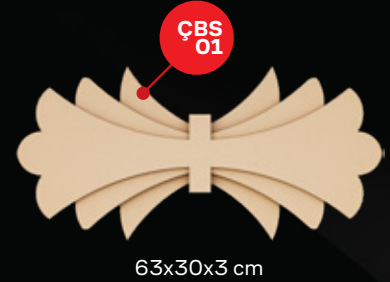

CBS 01

63x30x3 cm



CBS 02

50x31x3 cm



CBS 05

50x50x3 cm

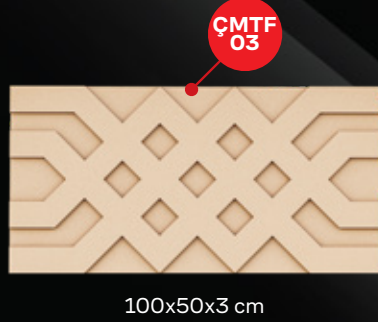

ÇMTF
21



50x50x4 cm

ÇMTF
24



50x50x4 cm

ÇMTF
25



50x50x4 cm

ÇMTF
26



50x50x4 cm

ÇMTF
27



80x98,5x4 cm

ÇMTF
28



50x100x4 cm

ÇMTF
30

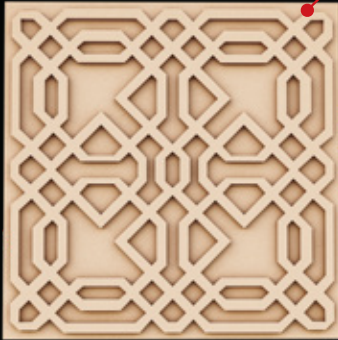

50x50x5 cm

ÇMTF
31



100x50x5 cm

ÇMTF
32



100x100x8 cm
100x120x8 cm

ÇMTF
33



100x100x4 cm

ÇMTF
35



200x98x4 cm

ÇMTF
36



255x119x2 cm

XPS hammaddeden üretilmektedir.

ÇMTF
37



273x180x2 cm

XPS hammaddeden üretilmektedir.

ÇMTF
38



150x80x2 cm

XPS hammaddeden üretilmektedir.

ÇMTF
39



198x58x2 cm

XPS hammaddeden üretilmektedir.

ÇMTF
40



150x2 cm

XPS hammaddeden üretilmektedir.

ÇMTF
41



199x50x2 cm

XPS hammaddeden üretilmektedir.

ÇMTF
42



65x56x2 cm

XPS hammaddeden üretilmektedir.

ÇMTF
43



198x90x2 cm

XPS hammaddeden üretilmektedir.

ÇMTF
44



200x50x5 cm

ÇMTF
45



200x50x5 cm

ÇMTF
46

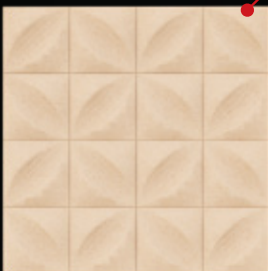

50x50 cm

ÇMTF
47



50x50 cm

ÇMTF
48



Ø 55 Ø 70

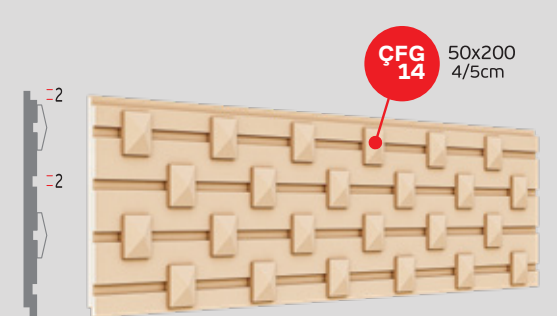

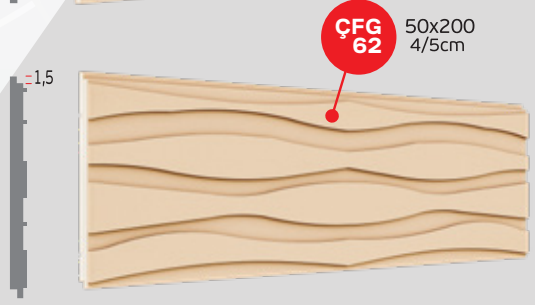

Kompozit görünümlü 50x200 4/5cm CFG 23



FUGA

Fair Coating

تلييس واجهات

ÇFG
79

50x200
5 cm



ÇFG
85

30x200
6 cm



ÇFG
80

50x200
3,5 cm



ÇFG
86

50x200
6 cm



ÇFG
82

30x200
4 cm

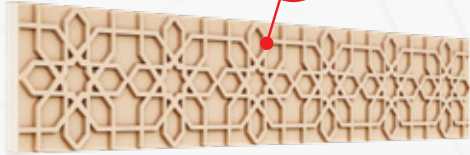

ÇFG
87

50x200
4 cm



ÇFG
83

50x200
5 cm



ÇFG
88

50x200
4 cm

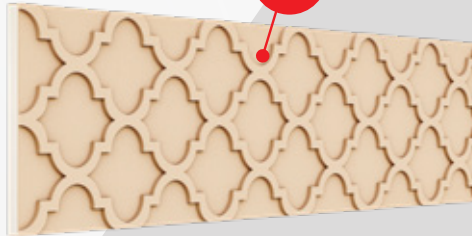

ÇFG
84

50x200
4 cm



ÇFG
89

50x200
4/5cm

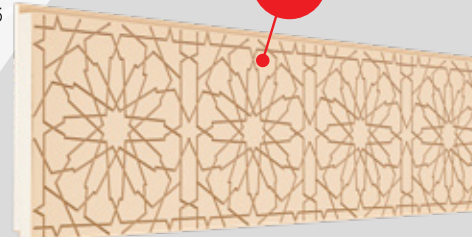

cukurova[®]
polistren dekor

İSTEDİĞİNİZ KAPLAMA VE
EPS KALINLIKLARINDA
ÜRETİM YAPILMAKTADIR.

ÇFG
35



120x50x5

ÇFG
46



130x50x4

ÇFG
36



120x50x4

ÇFG
47



120x50x5

ÇFG
37



130x50x4

ÇFG
59



120x50x5

ÇFG
38



130x50x4

ÇFG
60



120x50x5

ÇFG
39

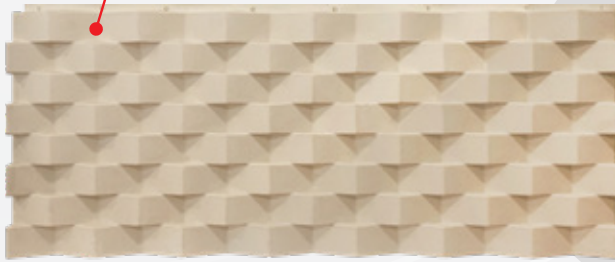

120x50x3,5

ÇFG
61



120x50x5

TUĞLA FUGA

Brick Fair Coating

والعزل أجوف لوحة

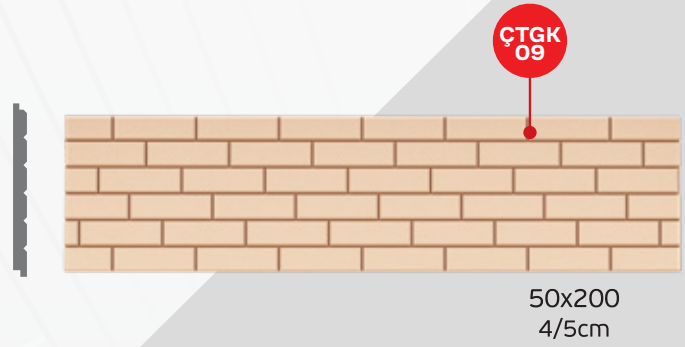
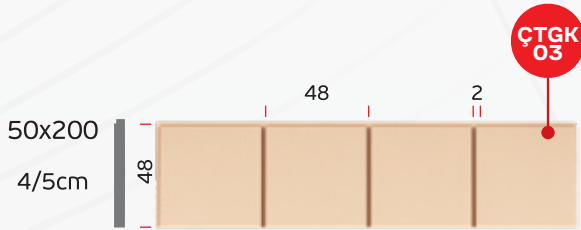
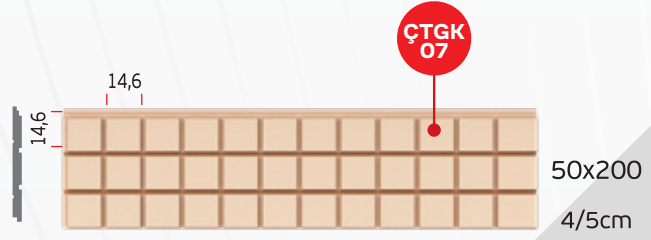
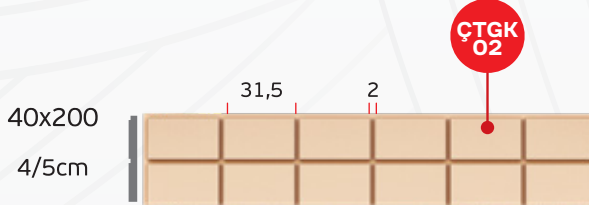
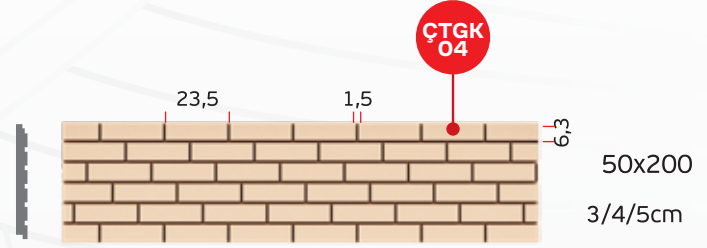
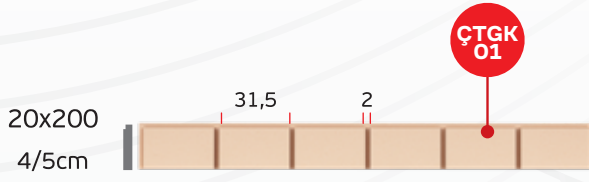

YALI BASKI

Shore Siding

تألييس واجهات

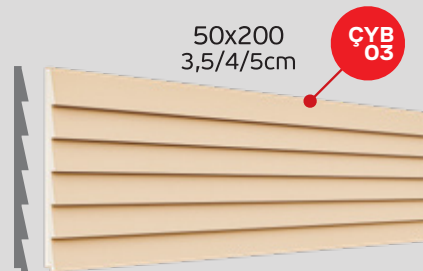
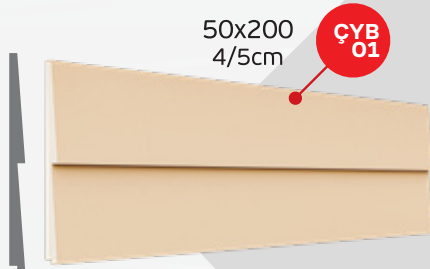

ÖRNEK PENCERE MODELLERİ

Sample Window Models
نماذج موديلات الشبابيك

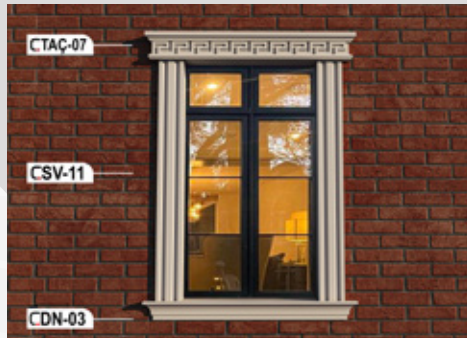
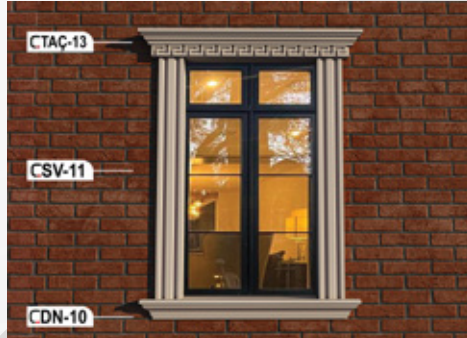
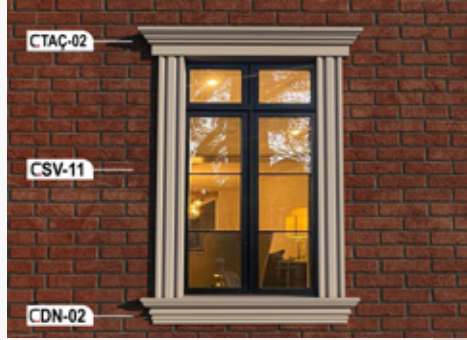
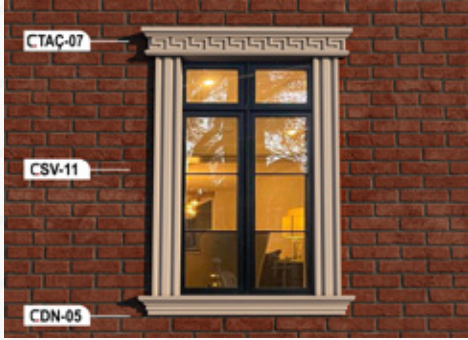
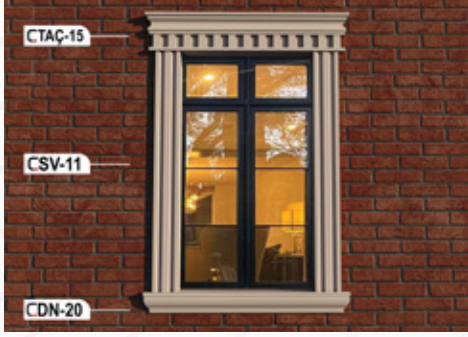

ÇYRD 01



5 Kg
Tamir Harcı
Repair Mortar
غراء التصليح



10 Kg
Tamir Harcı
Repair Mortar
غراء التصليح

ÇYRD 02



25 Kg
Yapıştırma Harcı
Thermal Insulation
Board Adhesive
غراء اللاصق



ÇYRD 05

Poliüretan Yapıştırıcı
Polyurethane Adhesives
لاصق البوليوريثين

ÇYRD 06



Tabanca Temizleyici
Cleaning Spray
منظف رشاش

ÇYRD 07



Tabanca
Colt
رشاش



ÇYRD 10

İç Cephe
Ürün Yapıştırıcısı
Interior Adhesive
لاصق فلين داخلي

**Çukurova
Polistren Dekor
farkıyla, projelerinize
güç katan en iyi kalite
yapıştırıcılar!**

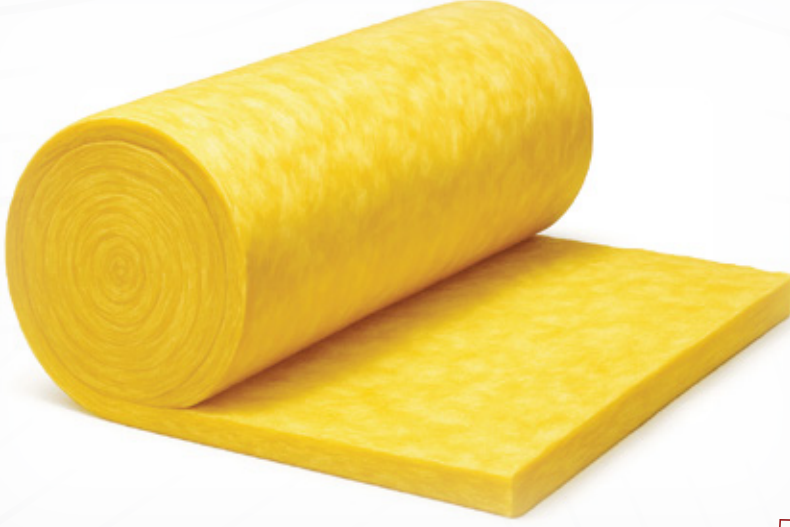

CAM YÜNÜ

Isı, ses ve yangın yalıtımı için kullanılan cam yünü; hafif yapısı sayesinde çatılarda, ara bölme duvarlarda ve havalandırma kanallarında tercih edilir. Kolay uygulanabilir ve enerji tasarrufu sağlar.

Taş yünü söve üretimini, yüksek standartlarda kendi tesislerimizde gerçekleştiriyoruz.

TAŞ YÜNÜ

Yüksek sıcaklığa dayanıklı ve ses yalıtımında etkili olan taş yünü, dış cephe mantolama, çatı ve döşeme sistemlerinde kullanılır. Yangına karşı dirençlidir ve yapı ömrünü uzatır.



FOAMBOARD KARTOPİYER

Estetik görünüm sunan ve uygulaması son derece pratik olan foamboard kartopiyer; iç mekân tavan ve duvar dekorasyonlarında kullanılır. Hafif yapısı sayesinde kolayca monte edilir, mekâna şıklık katar.



EPS BEYAZ YALITIM LEVHASI



EPS KARBONLU YALITIM LEVHASI



MANTOLAMA
SİSTEMLERİ
HER MEVSİM
YANINDA

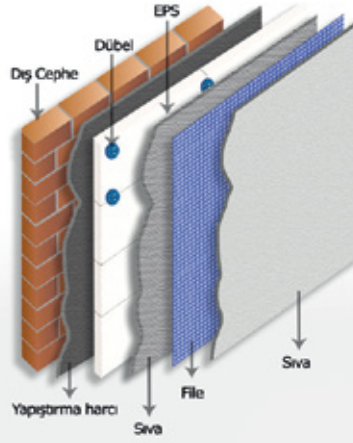

Güncel
Fiyat
Alınız!

MANTOLAMA PAKET ÖLÇÜLERİ	EBAT	POŞET İÇİ ADET	POŞET m ²	POŞET m ²	1 m ³ Kaç m ²
	3x50x100 cm	16 Ad.	8,00 m ²	0,24 m ²	33,33 m ²
	4x50x100 cm	12 Ad.	6,00 m ²	0,24 m ²	25 m ²
	5x50x100 cm	10 Ad.	5,00 m ²	0,25 m ²	20 m ²
	6x50x100 cm	8 Ad.	4,00 m ²	0,24 m ²	16,67 m ²
	7x50x100 cm	7 Ad.	3,50 m ²	0,245 m ²	14,29 m ²

MANTOLAMA PAKET İÇERİĞİ	MALZEMELER	MİKTARLAR
	EPS	50x100
	YAPIŞTIRMA HARCİ	4,5 kg m ²
	SIVA HARCİ	4,5 kg m ²
	DEKORATİF SIVA	2,5 kg m ²
	SIVA FİLESİ	160 gr (1,12 mt/m ²)
	DÜBEL	10-12cm (6m ² /ad)
KÖŞE PROFİLİ	0,25 mt/ m ²	

ÇYRD 08



Dekoratif Sıva

ÇYRD 11



Sıva Harcı

ÇYRD 14 Mantolama Dübeli



10x12 cm

ÇYRD 16



Sıva Filesi

ÇYRD 17

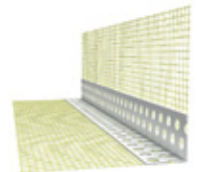

PVC Fileli Köşe Profili

GÜCÜNÜ RENKTE ALAN MEKÂNLAR İÇİN



Çukurova Polistren Dekor
Mobil Uygulamasıyla
Ürünlere **Anında Ulaşın.**
Projeleriniz İçin
İlham Verici Uygulama
Videolarını Keşfedin

Uygulamayı indirmek için
Hemen QR Kodu Okutun

To Download the App Scan the QR Code Now



SERTİFİKALARIMIZ



TSE BELGESİ



ISO 45001



YURTDIŞI
MARKA TESCİLİ



ISO 10002



ISO 14001



ISO 9001



CE TEST
BELGESİ



CE ANALİZ
BELGESİ

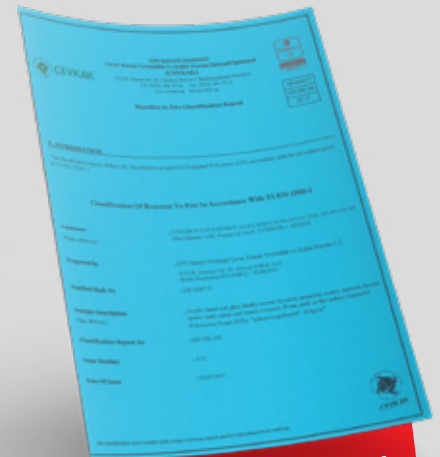

ALEV YÜRÜTMEZLİK
TEST BELGESİ

USTALARIN MALZEMESİ
MALZEMELERİN
USTASI

cukurova[®]
polistren dekor

+90 322 428 29 51
+90 322 428 29 52

info@cukurovapolistren.com
www.cukurovapolistren.com.tr

Acidere O.S.B. Gaziler Caddesi
No: 18 Sarıçam /ADANA / TURKEY

